



**STATE BANK OF PAKISTAN  
SBP BANKING SERVICES CORPORATION (BANK)**

**TENDER DOCUMENTS**

**VOLUME – I**

INVITATION TO BID  
INSTRUCTIONS TO BIDDERS  
BIDDING DATA  
FORM OF BID & APPENDICES TO BID  
STANDARD FORMS  
GENERAL CONDITIONS OF CONTRACT  
PARTICULAR CONDITIONS OF CONTRACT

**TECHNICAL BID**

**FOR**

**RENOVATION WORK OF LRC AUDITORIUM AT STATE BANK OF  
PAKISTAN HEAD OFFICE KARACHI**

**Feb-24**



## TABLE OF CONTENTS

Sr. No.	DESCRIPTION	Page(s)
<b>A</b>	<b>VOLUME – I: TECHNICAL BID</b>	
1	Invitation to Bid	
2	Instructions to Bidders	
3	Bidding Data	
4	Form of Bid & Appendices to Bid	
5	Standard Forms	
6	General Conditions of Contract (Part-I)	
7	Particular Conditions of Contract (Part-II)	
<b>B</b>	<b>VOLUME – II: TECHNICAL SPECIFICATIONS</b>	
<b>C</b>	<b>VOLUME III: DRAWINGS</b>	
<b>D</b>	<b>VOLUME IV: PREAMBLE TO BOQ &amp; BILL OF QUANTITIES</b>	
1	Letter of Price Bid	
2	Preamble to BOQ	
3	<b>Bill of Quantities (BOQ)</b>	





**STATE BANK OF PAKISTAN**  
SBP BANKING SERVICES CORPORATION  
Engineering Department, Bolton Market Office,  
M.A. Jinnah Road, Head Office Karachi

Reference No. ED/Proc-HOK/014483/24/161

**INVITATION TO BID**

**(AS PER PUBLISHED INVITATION TO BID)**



# INSTRUCTIONS TO BIDDERS



## INSTRUCTIONS TO BIDDERS

### TABLE OF CONTENTS

#### A. General

- IB.1 Scope of Bid
- IB.2 Source of Funds
- IB.3 Eligible Bidders
- IB.4 One Bid Per Bidder
- IB.5 Cost of Bidding
- IB.6 Site Visit

#### B. Bidding Documents

- IB.7 Contents of Bidding Documents
- IB.8 Clarification of Bidding Documents
- IB.9 Amendment of Bidding Documents

#### C. Preparation of Bids

- IB.10. Language of Bid
- IB.11 Documents Comprising the Bid
- IB.12 Bid Prices
- IB.13 Currencies of Bid and Payment
- IB.14 Bid Validity
- IB.15 Bid Security
- IB.16 Alternate Proposals by Bidder
- IB.17 Pre-Bid Meeting
- IB.18 Format and Signing of Bid

#### D. Submission of Bids

- IB.19 Sealing and Marking of Bids
- IB.20 Deadline for Submission of Bids
- IB.21 Late Bids
- IB.22 Modification, Substitution and Withdrawal of Bids

#### E. Bid Opening and Evaluation

- IB.23 Bid Opening
- IB.24 Process to be Confidential
- IB.25 Clarification of Bids
- IB.26 Examination of Bids and Determination of Responsiveness
- IB.27 Correction of Errors
- IB.28 Evaluation and Comparison of Bids

#### F. Award of Contract

- IB.29 Award
- IB.30 Employer's Right to Accept any Bid and to Reject any or all Bids
- IB.31 Notification of Award
- IB.32 Performance Security
- IB.33 Signing of Contract Agreement
- IB.34 General Performance of the Bidders
- IB.35 Integrity Pact
- IB.36 Instructions not Part of Contract

## INSTRUCTIONS TO BIDDERS

### A. GENERAL

- |                                |   |
|--------------------------------|---|
| <b>IB.1 Scope of Bid</b>       | <p>1.1 The Employer as defined in the Bidding Data Sheet hereinafter called “the Employer” wishes to receive bids for the construction and completion of works as described in these Bidding Documents, and summarized in the Bidding Data Sheet hereinafter referred to as the “Works”.</p> <p>1.2 The successful bidder will be expected to complete the Works within the time specified in Appendix-A to Bid.</p>  |
| <b>IB.2 Source of Funds</b>    | <p>2.1 The Employer has applied for/received a loan/credit from the source(s) indicated in the Bidding Data Sheet in various currencies towards the cost of the project specified in the Bidding Data Sheet and it is intended that part of the proceeds of this loan/credit will be applied to eligible payments under the Contract for which these Bidding Documents are issued.</p>  |
| <b>IB.3 Eligible Bidders</b>   | <p>3.1 This Invitation for Bids is open to all bidders meeting the following requirements:</p> <p style="padding-left: 20px;">a. Duly licensed by the Pakistan Engineering Council (PEC) in the category relevant to the value of the Works.</p>  |
| <b>IB.4 One Bid per Bidder</b> | <p>4.1 Each bidder shall submit only one bid either by himself, or as a partner in a joint venture. A bidder who participates in more than one bid (other than alternatives pursuant to Clause IB.16) will be disqualified.</p>   |
| <b>IB.5 Cost of Bidding</b>    | <p>5.1 The bidders shall bear all costs associated with the preparation and submission of their respective bids and the Employer will in no case be responsible or liable for those costs, regardless of the conduct or outcome of the bidding process.</p>   |
| <b>IB.6 Site Visit</b>         | <p>6.1 The bidders are advised to visit and examine the Site of Works and its surroundings and obtain for themselves on their own responsibility all information that may be necessary for preparing the bid and entering into a contract for construction of the Works. All cost in this respect shall be at the bidder’s own expense.</p> <p>6.2 The bidders and any of their personnel or agents will be granted permission by the Employer to enter upon his premises and lands for the purpose of such inspection, but only upon the express condition that the bidders, their personnel and agents, will release and indemnify the Employer, his personnel and agents from and against all liability in respect thereof and will be responsible for death or personal injury, loss of or damage to property and any other loss, damage, costs and expenses incurred as a result of such inspection.</p> |

### B. BIDDING DOCUMENTS

- |   |  |
|---|--|
| <b>IB.7 Contents of Bidding Documents</b> | <p>7.1 The Bidding Documents, in addition to invitation for bids, are those stated below and should be read in conjunction with any Addenda issued in accordance with Clause IB.9.</p> <ol style="list-style-type: none"> <li>1. Instructions to Bidders.</li> <li>2. Bidding Data Sheet.</li> </ol> |
|---|--|

3. General Conditions of Contract, Part-I (GCC).
  4. Particular Conditions of Contract, Part-II (PCC).
  5. Specifications – Special Provisions.
  6. Specifications – Technical Provisions.
  7. Form of Bid & Appendices to Bid.
  8. Bill of Quantities (Appendix-D to Bid).
  9. Form of Bid Security.
  10. Form of Contract Agreement.
  11. Forms of Performance Security and Mobilization Advance Guarantee/Bond and Form of Indemnity Bond for Secured Advance.
  12. Drawings.
- 7.2 The bidders are expected to examine carefully the contents of all the above documents. Failure to comply with the requirements of bid submission will be at the Bidder's own risk. Pursuant to Clause IB.26, bids which are not substantially responsive to the requirements of the Bidding Documents will be rejected.
- IB.8 Clarification of Bidding Documents**
- 8.1 Any prospective bidder requiring any clarification (s) in respect of the Bidding Documents may notify the Employer in writing at the Employer's address indicated in the Invitation for Bids. The Employer will respond to any request for clarification which he receives earlier than 28 days prior to the deadline for submission of bids.
- Copies of the Employer's response will be forwarded to all purchasers of the Bidding Documents, including a description of the enquiry but without identifying its source.
- IB.9 Amendment of Bidding Documents**
- 9.1 At any time prior to the deadline for submission of bids, the Employer may, for any reason, whether at his own initiative or in response to a clarification requested by a prospective bidder, modify the Bidding Documents by issuing addendum.
- 9.2 Any addendum thus issued shall be part of the Bidding Documents pursuant to IB 7.1 hereof and shall be communicated in writing to all purchasers of the Bidding Documents. Prospective bidders shall acknowledge receipt of each addendum in writing to the Employer.
- 9.3 To afford prospective bidders reasonable time in which to take an addendum into account in preparing their bids, the Employer may extend the deadline for submission of bids in accordance with Clause IB.20

## C. PREPARATION OF BIDS

- IB.10 Language of Bid**
- 10.1 The bid and all correspondence and documents related to the bid exchanged by a bidder and the Employer shall be in the bid language stipulated in the Bidding Data Sheet and Particular Conditions of Contract. Supporting documents and printed literature furnished by the bidders may be in any other language provided the same are accompanied by an accurate translation of the relevant parts in the bid language, in which case, for purposes of evaluation of the bid, the translation in bid language shall prevail.

**IB.11 Documents  
Comprising the  
Bid**

- 11.1 The Bid shall comprise two envelopes submitted simultaneously, one called the Technical Bid and the other the Price Bid, containing the documents listed in Bidding Data Sheet under the heading of IB 11.1 A & B respectively. Both envelopes to be enclosed together in an outer single envelope called the Bid. Each bidder shall furnish all the documents as specified in Bidding Data Sheet 11.1 A & B.
- 11.2 Bids submitted by a JV shall include a copy of the Joint Venture Agreement entered into by all partners. Alternatively, a Letter of Intent to execute a Joint Venture Agreement in the event of a successful bid shall be signed by all partners and submitted with the bid, together with a copy of the proposed agreement. The role to be played by each partner to be specified therein. Bids submitted by a joint venture of two (2) or more firms shall comply with the following requirements:
- a. In case of a successful bid, the Form of JV Agreement shall be signed so as to be legally binding on all partners within 7 days of the receipt of letter of acceptance failing which the contract and the letter of acceptance shall stand void and redundant.
  - b. One of the joint venture partners shall be nominated as being in charge; and this authorization shall be evidenced by submitting a power of attorney signed by legally authorized signatories of all the joint venture partners;
  - c. The partner-in-charge shall always be duly authorized to deal with the Employer regarding all matters related with and/or incidental to the execution of Works as per the terms and Conditions of JV Agreement and in this regard to incur any and all liabilities, receive instructions, give binding undertakings and receive payments on behalf of the joint venture;
  - d. All partners of the joint venture shall at all times and under all circumstances be liable jointly and severally for the execution of the Contract in accordance with the Contract terms and a statement to this effect shall be included in the authorization mentioned under Sub-Para (b) above as well as in the Form of Bid and in the Form of JV Agreement (in case of a successful bid); and
  - e. A copy of JV agreement shall be submitted before signing of the Contract, stating the conditions under which JV will function, its period of duration, the persons authorized to represent and obligate it and which persons will be directly responsible for due performance of the Contract and can give valid receipts on behalf of the joint venture, the proportionate participation of the several firms forming the joint venture, and any other information necessary to permit a full appraisal of its functioning. The JV Agreement shall be made part of the contract. No amendments / modifications whatsoever in the joint venture agreement shall be agreed to between the joint venture partners without prior written consent of the Employer.
- 11.3 The Bidder shall furnish, as part of the Technical Bid, a Technical Proposal including a statement of work methods, equipment, personnel, schedule and any other information as stipulated Bidding Forms, in sufficient detail to demonstrate the adequacy of



the Bidders' proposal to meet the work requirements and the completion time referred to in Sub-Clause 1.2 hereof.

- IB.12 Bid Prices**
- 12.1 Unless stated otherwise in the Bidding Documents, the Contract shall be for the whole of the Works as described in IB 1.1 hereof, based on the unit rates and / or prices submitted by the bidder.
- 12.2 The bidders shall fill in rates and prices for all items of the Works described in the Bill of Quantities. Items against which no rate or price is entered by a bidder will not be paid for by the Employer when executed and shall be deemed covered by rates and prices for other items in the Bill of Quantities.
- 12.3 All duties, taxes and other levies payable by the Contractor under the Contract, or for any other cause, as on the date 28 days prior to the deadline for submission of bids shall be included in the rates and prices and the total Bid Price submitted by a bidder.  
Additional / reduced duties, taxes and levies due to subsequent additions or changes in legislation shall be reimbursed / deducted as per Sub-Clause 70.2 of the General Conditions of Contract Part-I.
- 12.4 The rates and prices quoted by the bidders are subject to adjustment during the performance of the Contract in accordance with the provisions of Clause 70 of the Conditions of Contract. The bidders shall furnish the prescribed information for the price adjustment formulae in Appendix C to Bid and shall submit with the bids such other supporting information as required under the said clause.
- IB.13 Currencies of Bid and Payment**
- 13.1 The unit rates and the prices shall be quoted by the bidder entirely in Pak rupees. A bidder expecting to incur expenditures in other currencies for inputs to the Works supplied from outside the Employer's country (referred to as the "Foreign Currency Requirements") shall indicate the same in Appendix-B to Bid. The proportion of the Bid Price (excluding Provisional Sums) needed by him for the payment of such Foreign Currency Requirements either (i) entirely in the currency of the Bidder's home country or, (ii) at the bidder's option, entirely in Pak rupees provided always that a bidder expecting to incur expenditures in a currency or currencies other than those stated in (i) and (ii) above for a portion of the foreign currency requirements, and wishing to be paid accordingly, shall indicate the respective portions in his bid.
- 13.2 The rates of exchange to be used by the bidder for currency conversion shall be the TT & OD Selling Rates published or authorized by the State Bank of Pakistan prevailing on the date 28 days prior to the deadline for submission of bids. For the purpose of payments, the exchange rates used in bid preparation shall apply for the duration of the Contract.
- IB.14 Bid Validity**
- 14.1 Bids shall remain valid for the period stipulated in the Bidding Data Sheet after the Date of Bid Opening specified in Clause IB.23.

14.2 In exceptional circumstances, prior to expiry of the original bid validity period, the Employer may request that the bidders extend the period of validity for a specified additional period which shall in no case be more than the original bid validity period. The request and the responses thereto shall be made in writing. A bidder may refuse the request without forfeiting his Bid Security. A bidder agreeing to the request will not be required or permitted to modify his bid, but will be required to extend the validity of his Bid Security for the period of the extension, and in compliance with Clause IB.15 in all respects.

#### **IB.15 Bid Security**

15.1 Each bidder shall furnish, as part of his bid, a Bid Security in the amount stipulated in the Bidding Data Sheet in Pak Rupees or an equivalent amount in a freely convertible currency.

15.2 The Bid Security shall be, at the option of the bidder, in the form of Deposit at Call or a Bank Guarantee issued by a Scheduled Bank in Pakistan or from a foreign bank duly counter guaranteed by a Scheduled Bank in Pakistan in favor of the Employer valid for a period 28 days beyond the Bid Validity date.

15.3 Any bid not accompanied by an acceptable Bid Security shall be rejected by the Employer as non-responsive.

15.4 The bid securities of unsuccessful bidders will be returned as promptly as possible, but not later than 28 days after the expiration of the period of Bid Validity.

15.5 The Bid Security of the successful bidder will be returned when the bidder has furnished the required Performance Security and signed the Contract Agreement.

15.6 The Bid Security may be forfeited:

- a. if the bidder withdraws his bid except as provided in IB 22.1;
- b. if the bidder does not accept the correction of his Bid Price pursuant to IB 27.2 hereof; or
- c. In the case of successful bidder, if he fails within the specified time limit to:
  - i. furnish the required Performance Security
  - ii. sign the Contract Agreement; or

Furnish the required JV agreement within 7 days of the receipt of letter of acceptance.

#### **IB.16 Alternate Proposals by Bidder**

16.1 Should any bidder consider that he can offer any advantages to the Employer by a modification to the designs, specifications or other conditions, he may, in addition to his bid to be submitted in strict compliance with the Bidding Documents, submit any Alternate Proposal(s) containing (a) relevant design calculations; (b) technical specifications; (c) proposed construction methodology; and (d) any other relevant details / conditions, provided always that the total sum entered on the Letter of Price Bid shall be that which represents complete compliance with the Bidding Documents. The technical details and financial implication involved are to be submitted in two separate sealed envelopes as to be followed in main bid proposals.

16.2 Alternate Proposal(s), if any, of the lowest evaluated responsive bidder only may be considered by the Employer as the basis for the award of Contract to such bidder.

**IB.17 Pre-Bid Meeting**

- 17.1 The Employer may, on his own motion or at the request of any prospective bidder(s), hold a pre-bid meeting to clarify issues and to answer any questions on matters related to the Bidding Documents. The date, time and venue of pre-bid meeting, if convened, is as stipulated in the Bidding Data Sheet. All prospective bidders or their authorized representatives shall be invited to attend such a pre-bid meeting.
- 17.2 The bidders are requested to submit questions, if any, in writing so as to reach the Employer not later than seven (7) days before the proposed pre-bid meeting.
- 17.3 Minutes of the pre-bid meeting, including the text of the questions raised and the replies given, will be transmitted without delay to all purchasers of the Bidding Documents. Any modification of the Bidding Documents listed in IB 7.1 hereof, which may become necessary as a result of the pre-bid meeting shall be made by the Employer exclusively through the issue of an Addendum pursuant to Clause IB.9 and not through the minutes of the pre-bid meeting.
- 17.4 Absence at the pre-bid meeting will not be a cause for disqualification of a bidder.

**IB.18 Format and Signing of Bid**

- 18.1 Bidders are particularly directed that the amount entered on the Letter of Price Bid shall be for performing the Contract strictly in accordance with the Bidding Documents.
- 18.2 All appendices to Bid are to be properly completed and signed.
- 18.3 No alteration is to be made in the Letters of Price and Technical Bids nor in the Appendices thereto except in filling up the blanks as directed. If any such alterations be made or if these instructions be not fully complied with, the bid may be rejected.
- 18.4 The Bidder shall prepare one original of the Technical Bid and one original of the Price Bid comprising the Bid as described in Bidding Data Sheet against IB11 and clearly mark it "ORIGINAL TECHNICAL BID" and "ORIGINAL - PRICE BID". In addition, the Bidder shall submit two (2) copies of the Bid and clearly mark each of them "COPY." In the event of any discrepancy between the original and the copies, the original shall prevail.
- 18.5 The original and all copies of the Bid shall be typed or written in indelible ink and shall be signed by a person duly authorized to sign on behalf of the Bidder. This authorization shall consist of a written confirmation as specified in the Bidding Data Sheet and shall be attached to the bid. The name and position held by each person signing the authorization must be typed or printed below the signature. All pages of the Bid, except for unamended printed literature, shall be signed or initialed by the person signing the bid.
- 18.6 Any amendments such as interlineations, erasures, or overwriting shall be valid only if they are signed or initialed by the person signing the bid.
- 18.7 Bidders shall indicate in the space provided in the Letter of Technical and Price Bids, their full and proper addresses at which notices may be legally served on them and to which all correspondence in connection with their bids and the Contract is to be sent.



- 18.8 Bidders should retain a copy of the Bidding Documents as their file copy.

## D. SUBMISSION OF BIDS FOR SINGLE STAGE TWO ENVELOPE BIDDING PROCEDURE

### IB.19 Sealing and Marking of Bids

- 19.1 Each bidder shall submit his bid as under:
- a. ORIGINAL and each copy of the Bid shall be separately sealed and put in separate envelopes and marked as such.
  - b. The envelopes containing the ORIGINAL and copies will be put in one sealed envelope and addressed / identified as given in IB 19.2 hereof.
  - c. The technical bid should comprise of documents listed in IB11.1 (A) & the price bid should comprise of documents listed in IB 11.1 (B) which shall be placed in separate envelopes in accordance with IB 11.1.
- 19.2 The inner and outer envelopes shall:
- a. be addressed to the Employer at the address provided in the Bidding Data sheet;
  - b. bear the name and identification number of the contract as defined in the Bidding Data sheet; and
  - c. provide a warning not to open before the time and date for bid opening, as specified in the Bidding Data sheet.
- 19.3 In addition to the identification required in IB 19.2 hereof, the inner envelope shall indicate the name and address of the bidder to enable the bid to be returned unopened in case it is declared "late" pursuant to Clause IB.21.
- 19.4 If the outer envelope is not sealed and marked as above, the Employer will assume no responsibility for the misplacement or premature opening of the Bid.

### IB.20 Deadline for Submission of Bids

- 20.1
- a. Bids must be received by the Employer at the address specified no later than the time and date stipulated in the Bidding Data Sheet.
  - b. Bids with charges payable will not be accepted, nor will arrangements be undertaken to collect the bids from any delivery point other than that specified above. Bidders shall bear all expenses incurred in the preparation and delivery of bids. No claims will be entertained for refund of such expenses.
  - c. Where delivery of a bid is by mail and the bidder wishes to receive an acknowledgment of receipt of such bid, he shall make a request for such acknowledgment in a separate letter attached to but not included in the sealed bid package.
  - d. Upon request, acknowledgment of receipt of bids will be provided to those making delivery in person or by messenger.
- 20.2 The Employer may, at his discretion, extend the deadline for submission of Bids by issuing an amendment in accordance with Clause IB.9, in which case all rights and obligations of the Employer and the bidders previously subject to the original deadline will thereafter be subject to the deadline as extended.

### IB.21 Late Bids

- 21.1
- a. Any bid received by the Employer after the deadline for submission of bids prescribed in Clause IB.20 will be returned unopened to such bidder.

- b. Delays in the mail, delays of person in transit, or delivery of a bid to the wrong office shall not be accepted as an excuse for failure to deliver a bid at the proper place and time. It shall be the bidder's responsibility to determine the manner in which timely delivery of his bid will be accomplished either in person, by messenger or by mail.
- IB.22 Modification, Substitution and Withdrawal of Bids**
- 22.1 Any bidder may modify, substitute or withdraw his bid after bid submission provided that the modification, substitution or written notice of withdrawal is received by the Employer prior to the deadline for submission of bids.
- 22.2 The modification, substitution, or notice for withdrawal of any bid shall be prepared, sealed, marked and delivered in accordance with the provisions of Clause IB.19 with the outer and inner envelopes additionally marked "MODIFICATION", "SUBSTITUTION" or "WITHDRAWAL" as appropriate.
- 22.3 No bid may be modified by a bidder after the deadline for submission of bids except in accordance with IB 22.1 and 27.2.
- 22.4 Withdrawal of a bid during the interval between the deadline for submission of bids and the expiration of the period of bid validity specified in the Form of Bid may result in forfeiture of the Bid Security in pursuance to Clause IB.15.

### **E. BID OPENING AND EVALUATION FOR SINGLE STAGE TWO ENVELOPE BIDDING PROCEDURE**

- IB.23 Bid Opening**
- 23.1 The Employer will open the Technical Bids in public at the address, date and time specified in the Bidding Data Sheet in the presence of Bidders' designated representatives and anyone who choose to attend. The Price Bids will remain unopened and will be held in custody of the Employer until the specified time of their opening.
- 23.2 First, envelopes marked "WITHDRAWAL" shall be opened and read out and the envelope with the corresponding bid shall not be opened, but returned to the Bidder. No bid withdrawal shall be permitted unless the corresponding Withdrawal Notice contains a valid authorization to request the withdrawal and is read out at bid opening.
- 23.3 Second, outer envelopes marked "SUBSTITUTION" shall be opened. The inner envelopes containing the Substitution Technical Bid and/or Substitution Price Bid shall be exchanged for the corresponding envelopes being substituted, which are to be returned to the Bidder unopened. Only the Substitution Technical Bid, if any, shall be opened, read out, and recorded. Substitution Price Bid will remain unopened in accordance with IB 23.1.
- No envelope shall be substituted unless the corresponding Substitution Notice contains a valid authorization to request the substitution and is read out and recorded at bid opening.
- 23.4 Next, outer envelopes marked "MODIFICATION" shall be opened. No Technical Bid and/or Price Bid shall be modified unless the corresponding Modification Notice contains a valid authorization to request the modification and is read out and recorded at the opening of Technical Bids. Only the Technical Bids, both Original and Modification, are to be opened, read out, and recorded at the opening. Price Bids, both Original and Modification,



remain unopened in accordance with IB 23.1. The Bidders' representatives who are present shall be requested to sign the record. The omission of a Bidder's signature on the record shall not invalidate the contents and effect of the record. A copy of the record shall be distributed to all Bidders.

- 23.5 Other envelopes holding the Technical Bids shall be opened one at a time, and the following read out and recorded:
- a. the name of the Bidder;
  - b. whether there is a modification or substitution;
  - c. the presence of a Bid Security, if required; and
  - d. Any other details as the Employer may consider appropriate.

No Bid shall be rejected at the opening of Technical Bids except for late bids, in accordance with IB 21.1. Only Technical Bids read out and recorded at bid opening, shall be considered for evaluation.

#### Preliminary Examination of Technical Bids

- 23.6 a. The Employer shall first examine qualification and experience Data as per appendix M and N submitted by the Bidder. The technical proposal examination of those bidders only shall be taken in hand who meet the minimum requirement as mentioned in appendix M and N. Only substantially responsive qualification shall be considered for further evaluation.
- b. The Employer shall examine the Technical Bid to confirm that all the documents have been provided, and to determine the completeness of each document submitted.

- 23.7 The Employer shall confirm that all the documents and information have been provided for evaluation of Technical bid as required under these bidding documents.

- 23.8 At the end of the evaluation of the Technical Bids, the Employer will invite only those bidders who have submitted substantially responsive Technical Bids and who have been determined as being qualified for award to attend the opening of the Price Bids.
- The date, time, and location of the opening of Price Bids will be advised in writing by the Employer. Bidders shall be given reasonable notice for the opening of Price Bids.

- 23.9 The Employer will notify Bidders in writing who have been rejected on the grounds of their Technical Bids being substantially non-responsive to the requirements of the Bidding Document and return their Price Bids unopened before inviting others, who are determined as being qualified, to attend the opening of Price Bids.

- 23.10 The Employer shall conduct the opening of Price Bids of all Bidders who submitted substantially responsive Technical Bids, publically in the presence of Bidders' representatives who choose to attend at the address, date and time specified by the Employer. The Bidder's representatives who are present shall be requested to sign a register evidencing their attendance.

- 23.11 All envelopes containing Price Bids shall be opened one at a time and the following read out and recorded:
- (a) The name of the Bidder;
  - (b) Whether there is a modification or substitution;

(c) The Bid Prices, including any discounts and alternative offers; and

(d) Any other details as the Employer may consider appropriate.

Only Price Bids and discounts, read out and recorded during the opening of Price Bids shall be considered for evaluation. No Bid shall be rejected at the opening of Price Bids.

23.12 If this Bidding Document allows Bidders to quote separate prices for different contracts, and the award to a single Bidder of multiple contracts, the methodology to determine the lowest evaluated price of the contract combinations is that which is most economical to the Employer.

**IB.24 Process to be Confidential**

24.1 Information relating to the examination, clarification, evaluation and comparison of bid and recommendations for the award of a contract shall not be disclosed to bidders or any other person not officially concerned with such process before the announcement of bid evaluation report which shall be done at least ten 10 days prior to issue of Letter of Acceptance. The announcement to all Bidders will include table(s) comprising read out prices, discounted prices, price adjustments made, final evaluated prices and recommendations against all the bids evaluated. Any effort by a bidder to influence the Employer’s processing of bids or award decisions may result in the rejection of such bidder’s bid. Whereas any bidder feeling aggrieved may lodge a written complaint not later than fifteen (15) days after the announcement of the bid evaluation report. However mere fact of lodging a complaint shall not warrant suspension of the procurement process.

**IB.25 Clarification of Bids**

25.1 To assist in the examination, evaluation and comparison of bids, the Employer may, at his discretion, ask any bidder for clarification of his bid, including breakdowns of unit rates. The request for clarification and the response shall be in writing but no change in the price or substance of the bid shall be sought, offered or permitted except as required to confirm the correction of arithmetic errors discovered by the Employer in the evaluation of the bids in accordance with Clause IB.28.

25.2 If a Bidder does not provide clarifications of its Bid by the date and time set in the Employer’s request for clarification, its bid may be rejected.

**IB.26 Examination of Bids and Determination of Responsiveness**

26.1 Prior to the detailed evaluation of bids, the Employer will determine whether each bid is substantially responsive to the requirements of the Bidding Documents.

26.2 A substantially responsive bid is one which (i) meets the eligibility criteria; (ii) has been properly signed; (iii) is accompanied by the required Bid Security; (iv) Includes signed Integrity Pact where required as per clause IB.35 and (v) conforms to all the terms, conditions and specifications of the Bidding Documents, without material deviation or reservation. A material deviation or reservation is one (i) which affect in any substantial way the scope, quality or performance of the Works; (ii) which limits in any substantial way, inconsistent with the Bidding Documents, the Employer’s rights or the bidder’s obligations under the Contract; (iii) adoption/rectification whereof would affect unfairly the competitive position of other bidders presenting substantially



responsive bids. Only substantially responsive bid shall be considered for further evaluation.

- 26.3 If a bid is not substantially responsive, it may not subsequently be made responsive by correction or withdrawal of the non-conforming material deviation or reservation. The Employer may, however, seek confirmation/ clarification in writing which shall be responded in writing.
- IB.27 Correction of Errors**
- 27.1 Bids determined to be substantially responsive will be checked by the Employer for any arithmetic errors. Errors will be corrected by the Employer as follows:
- a. where there is a discrepancy between the amounts in figures and in words, the amount in words will govern; and
  - b. where there is a discrepancy between the unit rate and the line item total resulting from multiplying the unit rate by the quantity, the unit rate as quoted will govern, unless in the opinion of the Employer there is an obviously gross misplacement of the decimal point in the unit rate, in which case the line item total as quoted will govern and the unit rate will be corrected.
- 27.2 The amount stated in the Letter of Price Bid will be adjusted by the Employer in accordance with the above procedure for the correction of errors and with the concurrence of the bidder, shall be considered as binding upon the bidder. If the bidder does not accept the corrected Bid Price, his Bid will be rejected, and the Bid Security shall be forfeited in accordance with IB.15.6 (b) hereof.
- IB.28 Evaluation and Comparison of Bids**
- 28.1 The Employer will evaluate and compare only the Bids determined to be substantially responsive in accordance with Clause IB.26.
- 28.2 In evaluating the Bids, the Employer will determine for each Bid the evaluated Bid Price by adjusting the Bid Price as follows:
- a. making any correction for errors pursuant to Clause IB.27;
  - b. excluding Provisional Sums and the provision, if any, for contingencies in the Summary Bill of Quantities, but including competitively priced Day work; and
- making an appropriate adjustment for any other acceptable variation or deviation.
- 28.3 The estimated effect of the price adjustment provisions of the Conditions of Contract, applied over the period of execution of the Contract, shall not be taken into account in Bid evaluation.
- 28.4 If the Bid of the successful bidder is seriously unbalanced in relation to the Employer's estimate of the cost of work to be performed under the Contract, the Employer may require the bidder to produce detailed price analyses for any or all items of the Bill of Quantities to demonstrate the internal consistency of those prices with the construction methods and schedule proposed. After evaluation of the price analyses, the Employer may require that the amount of the Performance Security set forth in Clause IB.32 be increased at the expense of the successful bidder to a level sufficient to protect the Employer against financial loss in the event of default of the successful bidder under the Contract.





## F. AWARD OF CONTRACT

- |   |   |
|---|---|
| <b>IB.29 Award</b>  | <p>29.1 Subject to Clauses IB.30 and IB.34, the Employer will award the Contract to the bidder whose bid has been determined to be substantially responsive to the Bidding Documents and who has offered the lowest evaluated Bid Price, provided that such bidder has been determined to be eligible in accordance with the provisions of Clause IB.3 and qualify pursuant to IB 29.2.</p> <p>29.2 The Employer, at any stage of the bid evaluation, having credible reasons for or prima facie evidence of any defect in bidder's capacities, may require the bidders to provide information concerning their professional, technical, financial, legal or managerial competence whether already pre-qualified or not: Provided that such qualification shall only be laid down after recording reasons in writing. They shall form part of the records of that bid evaluation report.</p>  |
| <b>IB.30 Employer's Right to Accept any Bid and to Reject any or all Bids</b> | <p>30.1 Notwithstanding Clause IB.29, the Employer reserves the right to accept or reject any Bid, and to annul the bidding process and reject all bids, at any time prior to award of Contract, without thereby incurring any liability to the affected bidders or any obligation except that the grounds for rejection of all bids shall upon request be communicated to any bidder who submitted a bid, without justification of grounds. Rejection of all bids shall be notified to all bidders promptly.</p>   |
| <b>IB.31 Notification of Award</b>  | <p>31.1 Prior to expiration of the period of bid validity prescribed by the Employer, the Employer will notify the successful bidder in writing ("Letter of Acceptance") that his Bid has been accepted. This letter shall name the sum which the Employer will pay the Contractor in consideration of the execution and completion of the Works by the Contractor as prescribed by the Contract (hereinafter and in the Conditions of Contract called the "Contract Price").</p> <p>31.2 No Negotiation with the bidder having evaluated as lowest responsive or any other bidder shall be permitted.</p> <p>31.3 The notification of award and its acceptance by the bidder will constitute the formation of the Contract, binding the Employer and the bidder till signing of the formal Contract Agreement.</p> <p>31.4 Upon furnishing by the successful bidder of a Performance Security, the Employer will promptly notify the other bidders that their Bids have been unsuccessful and return their bid securities.</p> |
| <b>IB.32 Performance Security</b>   | <p>32.1 The successful bidder shall furnish to the Employer a Performance Security in the form and the amount stipulated in the Bidding Data Sheet and the Conditions of Contract within a period of 28 days after the receipt of Letter of Acceptance.</p> <p>32.2 Failure of the successful bidder to comply with the requirements of IB.32.1 or IB.33 or IB.35 shall constitute sufficient grounds for the annulment of the award and forfeiture of the Bid Security.</p>  |
| <b>IB.33 Signing of Contract Agreement</b>                                    | <p>33.1 Within 14 days from the date of furnishing of acceptable Performance Security under the Conditions of Contract, the Employer will send the successful bidder the Contract Agreement in the form provided in the Bidding Documents, incorporating agreements between the parties.</p>  |

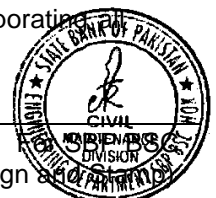

- 33.2 The formal Agreement between the Employer and the successful bidder shall be executed within 14 days of the receipt of the Contract Agreement by the successful bidder from the Employer.
- IB.34 General Performance of the Bidders** 34.1 The Employer reserves the right to obtain information regarding performance of the bidders on their previously awarded contracts/works. The Employer may in case of consistent poor performance of any Bidder as reported by the employers of the previously awarded contracts, inter-alia, reject his bid and/or refer the case to the Pakistan Engineering Council (PEC). Upon such reference, PEC in accordance with its rules, procedures and relevant laws of the land take such action as may be deemed appropriate under the circumstances of the case including black listing of such Bidder and debarring him from participation in future bidding for similar works.
- IB.35 Integrity Pact** 35.1 The Bidder shall sign and stamp the Integrity Pact provided at Appendix-L to Bid in the Bidding Documents for all Federal Government procurement contracts exceeding Rupees ten million. Failure to provide such Integrity Pact shall make the bidder non-responsive.
- IB.36 Instructions not part of Contract** 36.1 Bids shall be prepared and submitted in accordance with these Instructions which are provided to assist bidders in preparing their bids, and do not constitute part of the Bid or the Contract Documents.

# BIDDING DATA



**BIDDING DATA**

The following specific data for the Works to be bid shall complement, amend, or supplement the provisions in the Instructions to Bidders. Wherever there is a conflict, the provisions herein shall prevail over those in the Instructions to Bidders.

**Instructions to Bidders****Clause Reference****Clause IB.1          Scope of Bid****Sub Clause 1.1        Name and address of the Employer**

The Employer is:

**Director Engineering**

1<sup>st</sup> floor SBP Bolton Market Building  
State Bank of Pakistan (SBP) Banking Services Corporation (BSC)  
Head Office Karachi (HOK), M.A. Jinnah Road, Karachi

(Hereinafter called "The Employer" Which expression shall include the successors, legal representatives and permitted assignees).

**The Employer's Representative is:****Director Engineering**

Engineering Department  
1<sup>st</sup> floor SBP Bolton Market Building  
State Bank of Pakistan (SBP) Banking Services Corporation (BSC)  
Head Office Karachi (HOK), M.A. Jinnah Road, Karachi

**Name of the Project & Summary of the Works**

The name of the Project is:

Renovation Work of LRC Auditorium at State Bank of Pakistan Head Office Karachi

**Clause IB.2          Source of Funds**

**Sub Clause 2.1**        The Employer has sufficient funds of its own to cover the Cost of the entire Project for which these Bidding Documents are issued.

**Clause IB.4          One Bid per Bidder**

**Sub Clause 4.1**        Delete the text of Sub-Clause 4.1 and substitute with the following:

Each Bidder shall submit only one bid. Joint venture (JV) of the firms is not allowed. A bidder who submits or participates in more than one bid (other than alternatives pursuant to Clause IB.16) will be disqualified.

**Clause IB.6          Site Visit**

**Sub-Clause 6.1**        Sub-Clause 6.1 has been amended as under:

The bidders are advised to visit and examine the Site of Works and its surroundings and obtain for themselves on their own responsibility all information that may be necessary for preparing the bid and entering into a contract for construction of the Works. All cost in this respect shall be at the bidder's own expense. If the Bidder does not visit the site prior to submitting financial Bid, it is deemed that the Bidder understands the site conditions and price quoted by the Bidder is final.

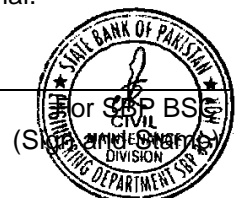

**Clause IB.7 Contents of Bidding Documents****Sub-Clause 7.1** Sub-Clause 7.1 is amended as under:

The Bidding Documents are those stated below, and should be read in conjunction with any Addenda issued in accordance with Clause IB.9.

**Technical Bid****7.1.1 Volume - I**

- (i) Instruction to Bidders.
- (ii) Bidding Data.
- (iii) Letter of Technical Bid & Appendices to Bid (excluding Appendix-D)
- (iv) Forms of Bid Security Performance Security, Contract Agreement, Mobilization Advance Bank Guarantee
- (v) Part-I - General Conditions of Contract.
- (vi) Part-II - Particular Conditions of Contract.
- (vii) Bid Security

**Price Bid****7.1.2 Volume - II**

- (i) Preamble to Bill of Quantities
- (ii) Appendix – D to Bid (Bill of Quantities)

**Clause IB.8 Clarification of Bidding Documents****Sub-Clause 8.1 Time limit for clarification**

Sub-Clause 8.1 has been amended as under:

Any prospective bidder requiring any clarification(s) in respect of the Bidding Documents may notify the Employer in writing at the Employer's address indicated in the Invitation for Bids. The Employer will respond to any request for clarification which he receives earlier than 14 days prior to the deadline for submission of bids.

Copies of the Employer's response will be forwarded to all purchasers of the Bidding Documents and shall also be uploaded at SBP website along-with tender documents, including a description of the enquiry but without identifying its source.

**Clause IB.10 Language of Bid****Sub-Clause 10.1** English.**Clause IB.11 Documents Accompanying the Bid****Sub-Clause 11.1** Sub–Clause 11.1 has been amended as under:**11.1 (A)** The Bidder shall submit with its **Technical Bid** the following documents:**Volume – I**

- (i) Letter of Technical Bid
- (ii) Bid Security shall be submitted with the Technical Proposal Envelope
- (iii) Written power of attorney authorizing the signatory of the Bid
- (iv) Original Bidding Documents (Volume – I)
- (v) Duly filled in Schedules to Bid (except Appendix-D to Bid)
- (vi) Qualification documents establishing bidders' eligibility as per Appendix-M

**11.1 (B)** The Bidder shall submit with its **Price Bid** the following documents:**Volume – II**

- (i) Preamble to Bill of Quantities
- (ii) Appendix – D to Bid (Bill of Quantities)

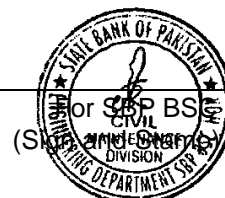

**Sub-Clause 11.3** The Bidder shall also submit along with the Bid the entire original document issued to him comprising Volume-I to Volume-II.

**Clause IB.12 Bid Prices**

**Sub-Clause 12.3** Sub–Clause 12.3 has been amended as under:

The Bidder shall obtain all information as to all applicable Taxes and conform to the requirements thereof at his own responsibility and include the same in his **quoted Bid Price**.

The quoted Bid Price shall also include the cost of accepting the general risks/liabilities and obligations set forth or implied in the Contract. No claim at any later stage on this account will be entertained.

All applicable duties, applicable taxes, stamp duty and other levies payable by the Contractor under the Contract, or for any other cause, as on the date 28 days prior to the deadline for submission of bids shall be included in the rates and prices and the total Bid Price submitted by a bidder. **State Bank of Pakistan is not to be treated as Government Entity for this purpose therefore 100% applicable taxes etc. will be recovered.**

Additional / reduced duties, taxes and levies due to subsequent additions or changes in legislation shall be reimbursed / deducted as per Sub-Clause 70.2 of the General Conditions of Contract Part-I.

**Sub-Clause 12.4** Sub–Clause 12.4 has been amended as under:

The rates and prices quoted by the bidders are subject to adjustment during the performance of the Contract in accordance with the provisions of Clause 70 of the Conditions of Contract.

**Clause IB.13 Currencies of Bid and Payment**

**Sub-Clause 13.1** Sub–Clause 13.1 has been amended as under:

The unit rates and the prices shall be quoted by the bidder in Pak Rupees. The payments to the Contractor for the works done shall be made in Pakistani Rupees.

**Sub-Clause 13.2** Delete Sub–Clause 13.2.

**Clause IB.14 Bid Validity**

**Sub-Clause 14.1 Period of Bid validity**

One hundred eighty two (182) days.

**Clause IB.15 Amount of Bid Security**

**Sub-Clause 15.1** Bid Security shall be of Rs.700,000/-.

**Sub-Clause 15.2**

Each bidder shall be in the shape of Pay Order / Demand Draft /Deposit or a Bank Guarantee issued by a Scheduled Bank in Pakistan or from a foreign bank duly counter guaranteed by a Scheduled Bank in Pakistan in favor of the Employer at call in favor of SBP-Banking Service Corporation valid for period equal to Bid Validity period. The Bid Security in original is required to be submitted with Technical Bid.

Bid Security shall be submitted with the Technical Bid Envelope. Failure shall result in non-responsiveness and the bid shall be returned.

**Clause IB.16 Alternate Proposals by Bidder**

The text of this sub-clause is deleted and replaced with following.

“Alternate Proposals are not allowed. Bidders offering more than one proposal shall be disqualified and its bid shall be deemed to be non-responsive”.

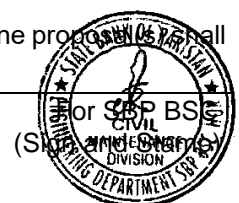

**Clause IB.17 Pre-Bid Meeting**

Will not be held.

**Clause IB.18 Format and Signing of Bid****Sub-Clause 18.4 Number of copies of Bid:**

The Sub–Clause 18.4 has been amended as under:

Each bidder shall prepare and submit all documents in original along with the documents as described in Clause IB-11.1 and 19.1 of the Instructions to Bidders, bound with the volume containing the Form of Bid, and clearly marked "**ORIGINAL**".

**Sub-Clause 18.5** The Sub–Clause 18.5 has been amended as under:

The Bid shall be written in indelible ink and shall be signed by a person or persons duly authorized to sign on behalf of the Bidder pursuant to Sub-Clause 11.1(a) hereof. All pages of the Bid shall be initialed and stamped by the person or persons signing the Bid. One (1) copy of Power of Attorney must be attached to the Bid submitted to the Employer if this Bid is signed / executed by a person other than the President, Partner or Owner of the Bidder's Company.

**Clause IB.19 Sealing and Marking of Bids****Sub-Clause 19.1** The Sub–Clause 19.1 has been amended as under:

Each Bidder shall submit his Bid as under:

- (a) **ORIGINAL** Bid Comprising Volume-I including Addendum/Corrigendum and supporting documents, Volume-II, sealed separate envelopes marked as Volume-I and Volume-II, respectively and put into large envelope named as **ORIGINAL**.
- (b) Bid Security shall be put in a separate envelope. The envelope of Bid Security shall be sealed with the envelope of Technical Bid (Volume-I). The envelopes containing the Original Bid and other Bid documents shall be put in a larger envelope, which will be properly sealed and returned by the fixed date and time of Bid submission as specified in the Notice Inviting Bids.

**Sub-Clause 19.2** (a) Employer's address for the purpose of Bid submission is as follows:

**Director Engineering**  
Engineering Department  
1<sup>st</sup> floor SBP Bolton Market Building  
State Bank of Pakistan (SBP) Banking Services Corporation (BSC)  
Head Office Karachi (HOK), M.A. Jinnah Road, Karachi

- (b) Name & identification number of the Contract is as follows:  
Renovation of SBP Auditorium at 3rd Floor LRC Building Karachi"

**Identification Number: Not Applicable**

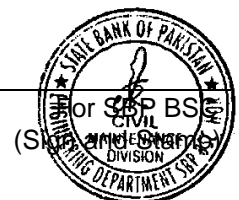
**Clause IB.20 Deadline for Submission of Bids****Sub-Clause 20.1(a)** Time and date of Bid submission and Bid opening shall be as per the data provided in the Notice Inviting Bids.**Clause IB.23 Bid Opening**

**Sub-Clause 23.1 Venue, time, and date of Bid opening.**

As provided in Notice Inviting Bids.

**Sub-Clause 23.6** Delete the word "N".**Clause IB.24 Process to be Confidential****Sub-Clause 24.1** In case of grievance, the address of Grievances Committee is:

**Chairman Grievance Committee,**  
Office of the Director Human Resource Management Department,  
1<sup>st</sup> Floor, BSC House State Bank of Pakistan Main Building Complex,  
I.I Chundrigar Road, Karachi.

**Clause IB.26 Examination of Bids and Determination of Responsiveness****Sub-Clause 26.2** The Sub–Clause 26.2 has been amended as under:

A substantially responsive bid is one which (i) meets the eligibility criteria; (ii) has been properly signed; (iii) is accompanied by the required Bid Security; (iv) Includes signed Integrity Pact where required as per clause IB.35 and (v) conforms to all the terms, conditions and specifications of the Bidding Documents, without material deviation or reservation (vi) determined as qualified. A material deviation or reservation is one (i) which affect in any substantial way the scope, quality or performance of the Works; (ii) which limits in any substantial way, inconsistent with the Bidding Documents, the Employer's rights or the bidder's obligations under the Contract; (iii) adoption/rectification whereof would affect unfairly the competitive position of other bidders presenting substantially responsive bids. Only substantially responsive bid shall be considered for further evaluation.

**Clause IB.28 Evaluation and Comparison of Bids****Sub-Clause 28.4** The sub-clause 28.4 is deleted and replaced with following:

**“If the rate of any item of the successful bidder is abnormally high i.e. 15% more or higher than the rate of the same items in Engineer’s Estimate, the Employer may require the bidder to produce detailed price analyses for any or all such items of Bid of the successful Bidder to demonstrate the internal consistency of those prices. After evaluation of the price analyses by the Employer / Engineer the rate of successful bidder (if required) will be rationalized in following manner and the decision of the Employer / Engineer in this regard shall be final and binding on the successful bidder:**

- a. The rate or price of individual abnormally high quoted items compared with the Engineer's Estimate would be decreased to the individual item rate of the Engineer's Estimate. The revised BOQ so prepared will be called as Rationalized BOQ duly stamped and signed by the successful bidder which shall be final and binding for interim payment purposes only. Withheld amount(s) of abnormally high quoted items shall be released during finishes stage or at such stage when items identified as below / lower to Engineer's estimate are in progress resulting in making final payments as per original quotes.

**Clause IB.29 Award****Sub-Clause 29.1** The sub-clause 29.1 is deleted and replaced with following:

Subject to clauses IB.30 and IB.34, the Employer will award the Contract to the bidder whose bid has been found Most Advantageous Bid i.e. the bid which has been determined to be substantially responsive to the eligibility criteria and other terms of Bidding Documents and who has offered the lowest evaluated Bid Price.

**Clause IB.31 Notification of Award**



**Sub-Clause 31.2** The sub-clause 31.2 is deleted and replaced with following:

No Negotiation with the bidder having evaluated as most advantageous or any other bidder shall be permitted.

**Clause IB.32 Performance Security**

**Sub-Clause 32.1** Delete the text of Sub–Clause 32.1 and substitute with the following:

The Contractor shall obtain and provide to the Employer a Performance Security in the prescribed Form annexed to these Bidding / Contract Documents. The said security shall be furnished to the Employer by the Contractor within twenty-eight (28) days after the receipt of Letter of Acceptance. The Performance Security shall be of an amount equal to ten percent (10%) of the Contract Price stated in the Letter of Acceptance.

Performance Security valid till expiration of Defect Liability Period is required to be submitted in the shape of Pay order/ Demand Draft/ Deposit at call /Bank Guarantee from any Scheduled Bank in Pakistan or from a bank located outside Pakistan duly counter-guaranteed by a Scheduled Bank in Pakistan or Insurance Guarantsee from any insurance company with AA rating by PACRA / JCR.

The amount in the form of Pay Order, Demand Draft or Deposit at call will be encashed by the Employer upon submission of Performance Security.

Notwithstanding anything contained in the Contract and / or applicable law, Performance Security shall be forfeited if the Contractor fails to perform the Contract.

**Sub-Clause 32.2** Delete the text of Sub–Clause 32.2 and substitute with the following:

Failure of the successful bidder to comply with the requirements of Sub-Clause IB.28.4 or Sub-Clause IB.32.1 or Clauses IB.33 or IB.35 shall constitute sufficient grounds for the annulment of the award and forfeiture of the Bid Security.

**Clause IB.33 Signing of Contract Agreement**

**Sub-Clause 33.1** Sub–Clause 33.1 has been amended as under:

The successful Bidder shall submit along with the Performance Security, Contract Agreement as per the Form of Agreement within the time period stipulated in clause IB- 32.1 provided in the Bidding Documents, incorporating all agreements between the parties.

**Sub-Clause 33.2** The formal Agreement between Employer the successful bidder will be executed within twenty-one (21) days after the receipt / approval / verification of the Contract Agreement and Performance Security and evidence to insurance as per Sub-Clause 32.1 hereof.

Add the following Clauses:

**Clause IB.37 Black listing Mechanism**

Code of Conduct:

- a) It is the Employer's policy that the bidders observe the highest standards of ethics during the procurement and execution of such contracts. In pursuit of this policy, the Employer follows, inter alia, the instructions contained in PPR–2004 which defines:
- (i) “coercive practices” which means any impairing or harming or threatening to impair or harm, directly or indirectly, any party or the property of the party to influence the actions of a party to achieve a wrongful gain or to cause a wrongful loss to another party;
  - (ii) “collusive practices” which means any arrangement between two or more parties to the procurement process designed to stifle open competition for any wrongful gain, and to establish prices at artificial, non-competitive



- (iii) “corrupt practices” which means the offering, giving, receiving or soliciting, directly or indirectly, of anything of value to influence the acts of another party for wrongful gain;
  - (iv) “fraudulent practices” which means any act or omission, including a misrepresentation, that knowingly or recklessly misleads, or attempts to mislead, a party to obtain a financial or other benefit or to avoid an obligation; and
  - (v) “obstructive practices” which means harming or threatening to harm, directly or indirectly, persons to influence their participation in a procurement process, or affect the execution of a contract.
- b) Under Rule-19 of PPR-2004, the Employer can inter alia blacklist and debar bidders found to be indulging in corrupt or fraudulent practices mentioned at para a) above. Such matters would be referred to the Blacklisting Committee of the Employer that is empowered to take actions accordingly. Such blacklisting or barring action shall be communicated by the Employer to PPRA and the Bidder in the form of decision containing the grounds for such action. :

Nature of Fault	Means of Verification
<b>Corruption</b>	Actual instance verifiable as per law of land and applicable rules and regulations of SBP
<b>Deviation from commitment</b>	If the bidder deviates from its prior commitment or declaration made regarding the bid or proposal submitted by the bidder.
<b>Fraud</b>	Cross verification of documentary undertakings submitted by Bidder
<b>Collusion</b>	Results of Bid analysis resulting in substantive evidence of collusion

**Clause IB.38****Overriding Effect of PPR – 2004**

Whenever in conflict with these documents the stipulations of PPR-2004 (Public Procurement Rules-2004) shall prevail.

**Clause IB.39****Bid Discount**

Omitted as PPR Rule 38A.

**Clause IB.40****Confidentiality****Sub-Clause B.40.1**

Information relating to evaluation of bids and recommendations concerning to award of the contract shall not be disclosed by the Employer to the bidders or to any other person who is not officially concerned with the process, until the announcement of the result of evaluation.

**Sub-Clause B.40.2**

The Bidder shall not disclose or attempt to make public any information relating to the bidding documents, bidding process and award of the contract to any person or entity without the Employer’s prior written consent.

**Sub-Clause IB.40.3**

In case of any disclosure related to the bidding process and contractual obligations at any stage by any bidder and/or contractor, the Employer may reject its bid and/or terminate the contract.



# FORM OF BID AND APPENDICES TO BID



**FORM OF BID**

Date: .....

**Renovation Work of LRC Auditorium at State Bank of Pakistan  
Head Office Karachi**

To:

**Director**  
Engineering Department  
1<sup>st</sup> Floor SBP Bolton Market Building  
State Bank of Pakistan SBP, BSC  
M.A. Jinnah Road, Karachi

We, the undersigned, declare that:

- a) We have examined and have no reservations to the Bidding Documents, including Addenda issued in accordance with Instructions to Bidders (IB) 9;
- b) We offer to execute and complete in conformity with the Bidding Documents the following Works:  
  
"Renovation of SBP Auditorium at 3rd Floor LRC Building Karachi"
- c) We understand that all the Appendices attached hereto form part of this Bid. Our Bid consisting of the Technical Bid and the Price Bid shall be valid for a period of 182 days from the date fixed for the bid submission deadline in accordance with the Bidding Documents, and it shall remain binding upon us and may be accepted at any time before the expiration of that period;
- d) We undertake, if our Bid is accepted, to commence the Works and to complete the whole of the Works comprised in the Contract within the time stated in Appendix-A to Bid.
- e) As security for due performance of the under takings and obligations of our bid, we submit herewith a Bid security, in the amount specified in Bidding Data Sheet, which is valid (at least) 28 days beyond validity of Bid itself.
- f) We are not participating, as a Bidder or as a subcontractor, in more than one bid in this bidding process, other than alternative offers submitted in accordance with IB16 (as applicable).
- g) We agree to permit Employer or its representative to inspect our accounts and records and other documents relating to the bid submission and to have them audited by auditors. This permission is extended for verification of any information provided in our Technical Bid which comprises all documents enclosed herewith in accordance with IB.11.1 of the Bidding Data Sheet.
- h) We do hereby declare that the Bid is made without any collusion, comparison of figures or arrangement with any other bidder for the Works.

Name.....

In the capacity of.....

Signed.....

Duly authorized to sign the Bid for and on behalf of .....

Date .....

Address.....



**BA-1**  
**Appendix-A to Bid**

**SPECIAL STIPULATIONS CLAUSE**  
**Conditions of Contract**

1.	Engineer's Authority to Issue Variation in emergency	2.1	2% of the Contract Price stated in the Letter of Acceptance
2.	Law applicable	5.1(b)	The law to be applied is the law of Islamic Republic of Pakistan.
3.	Amount of Performance Security	10.1	10% of Contract Price stated in the Letter of Acceptance.
4.	Time for Furnishing Programme	14.1	Within 28 days from the date of receipt of Letter of Acceptance
5.	Minimum amount of Third Party Insurance	23.2	Rupees Rs. 200,000 per occurrence
6.	Time for Commencement	41.1	Within fourteen (14) days from the date of Engineer's Notice to Commence which shall be issued within fourteen (14) days after signing of Contract Agreement.
7.	Time for Completion	43.1	360 days from the date of receipt of Engineer's Notice to Commence.
8.	Amount of Liquidated Damages	47.1	0.1% of Contract Price for each day of delay in completion of the Works subject to a maximum of ten percent (10%) of Contract Price stated in Letter of Acceptance.
9.	Defects Liability Period	49.1	365 days from the effective date of Taking Over Certificate.
10.	Percentage of Retention Money	60.2	5% of the amount of Interim Payment Certificate
11.	Limit of Retention Money	60.2	5% of Contract Price stated in the Letter of Acceptance
12.	Minimum amount of Interim Payment Certificates (Running Bills)	60.2	Minimum amount of Interim Payment Certificate shall be Rupees two (02) Millions.
13.	Time of Payment from delivery of Engineer's Interim Payment Certificate to the Employer	60.10	Twenty eight (28) days.
14.	Mobilization Advance (Interest Free)	60.11	Up to 15 % of Contract Price as stated in the Letter of Acceptance.



**FOREIGN CURRENCY REQUIREMENTS**  
**(If required and only in case of International Bidding)**

**NOT USED**



**PRICE ADJUSTMENT UNDER CLAUSE 70  
OF CONDITIONS OF CONTRACT**

The source of prices and the weightages for use in the adjustment formula under Clause 70 shall be as follows:

Cost Element	Description	Weightages	Applicable index
1	2	3	4
(i)	Fixed Portion	0.691	
(ii)	Local Labour	0.226	Government of Pakistan (GP) Federal Bureau of Statistics (FBS) Monthly Statistical Bulletin.
(iii)	G.S. Sheet-24 Gauge, Galvanized - Framing & Ducting works	0.033	" " "
(viii)	High Speed Diesel (HSD)	0.05	" " "
	Total	1.000	

**Notes:**

- 1) The base date price (or base date index) of any element shall be the price of the element for the month on the day falling 28 days prior to the latest day for submission of bids.
- 2) The current date price (or current date index) of any element shall be the price of the element for the month falling on the day 28 days prior to the last day of the period to which the particular Payment Certificate relates
- 3) Any fluctuation in the indices or prices of materials other than those given above shall not be subject to adjustment of the Contract Price.
- 4) Except labour and POL, if any other adjustable item(s) is not used in a particular billing period then the ratio of the current date price and base date price for that particular adjustable item(s) shall be considered as one.

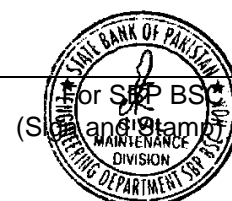

**BILL OF QUNATITIES**  
(to be filled and signed by the  
Bidder)

**(Separately attached as Volume II)**





**PROPOSED CONSTRUCTION SCHEDULE**  
(to be filled and signed by the Bidder)

Bidder shall provide a program in a bar-chart showing the sequence of work items by which he proposes to complete the Works of the entire Contract. The program should indicate the sequence of work items and the period of time during which he proposes to complete the Works including the activities like designing, schedule of submittal of drawings, ordering and procurement of materials, manufacturing, delivering, construction of civil works, erection, testing and commissioning of Works to be supplied under the Contract. The proposed sequence of execution of various sections of the project shall be according to the given Key Performance Indicators (KPIs) as following:

Sr. No.	Description of Activity	Total Days	Start Date	Finish Date	Civil Works									
					0-45	46-90	91-135	136-180	181-225	226-270	271-315	316-360		
1	Anti-termite treatment at ground floor of the building	5												
2	Supply of New Fan Coil Units	60												
3	Submission of electrical samples & shop drawings	10												
4	Submission of carpet tile sample	10												
5	Approvals from Bank	5												
6	Placement of order for material	10												
7	Delivery of Wiring Material	10												
8	Delivery of Lights	60												
9	Dismantling of civil / electrical / HVAC	45												
10	Overhauling of Air devices including diffusers, dampers	15												
11	Overhauling of Air-handling unit	30												
12	Starighting & Retrofitting of trusses	60												
13	Painting of steel structure	10												
14	Laying of pre-cast roofing	15												
15	Laying of screed above pre-cast roofing	15												
16	Wiring works	90												
17	Reinstallation of Existing ducting, fixing of Sound Liner	30												
18	Supply & Installation of New Ducting	15												
19	Laying of waterproofing membrane	5												
20	Anti-termite treatment of Auditorium	5												
21	Installation, Testing Commissioning of Fan Coil Unit	15												
22	Fixing of new false ceiling	30												
23	Fixing of new wall panelling	30												
24	Lights Installations	45												
25	Wet work for constructing stage including masonry, plaster, precast slab works	20												
26	Coloring works in entire Auditorium	10												
27	Fixing of wooden flooring at stage	5												
28	Fixing of carpet tiles & nosing on steps	45												
29	Re-fixing of chairs	10												
30	Punch List works & Handing/Taking Over	30												
		Total duration of Project	360 calendar days											

The above Key Performance Indicators should be taken into consideration by the bidder in order to execute the works.

Signatures:

Stamp:

If the above KPI is not acceptable to any bidder, the bidder will prepare its own Work Program along with detailed justification for its change. Bids without above given Work Program or bidder’s own proposed Work Program without justification shall not be considered responsive.

Authorized Signature and official Seal: \_\_\_\_\_

Name: \_\_\_\_\_

Date: \_\_\_\_\_



**METHOD OF PERFORMING THE WORK**

The Bidder is required to submit a narrative outlining the method of performing the Work. The narrative should indicate in detail and include but not be limited to:

1. The Bidder shall submit detailed methodology of work covered under BOQ Items
  - a. Item No.7 of Section-A2
  - b. Item No.13 & 14 of Section B



**BG-1**

**Appendix-G to Bid**

**LIST OF MAJOR EQUIPMENT – RELATED ITEMS  
Not Applicable**



**BG-2**  
**Appendix-G to Bid**

**EQUIPMENT:**

Not Applicable



**BIDDER'S MINIMUM MANDATORY REQUIREMENT OF EQUIPMENT FOR RELEASING SECOND PART OF MOBILIZATION ADVANCE**

Not applicable



**CONSTRUCTION CAMP AND HOUSING FACILITIES**

Not Applicable



**LIST OF SUBCONTRACTORS**

The Contractor undertakes that if any part of the Works is subcontracted, the subcontractors shall be reliable and competent as per PEC bye laws to perform that part of the work and shall have adequate experience of the similar works. Contractor understands that final selection of subcontractor will be subject to the Employer's approval.



**ESTIMATED PROGRESS PAYMENTS**

**Not Applicable**





**BK-1**  
**Appendix-K to Bid**

**ORGANIZATIONAL CHART  
FOR THE SUPERVISORY STAFF**

**Not Applicable**



**(INTEGRITY PACT)**

**DECLARATION OF FEES, COMMISSION AND BROKERAGE ETC. PAYABLE BY THE SUPPLIERS OF GOODS, SERVICES & WORKS IN CONTRACTS WORTH RS. 10.00 MILLION OR MORE**

Contract No. \_\_\_\_\_ Dated \_\_\_\_\_ Contract Value: \_\_\_\_\_  
Contract Title: \_\_\_\_\_

..... [Name of Contractor] hereby declares that it has not obtained or induced the procurement of any contract, right, interest, privilege or other obligation or benefit from Government of Pakistan (GoP)/autonomous body or any administrative subdivision or agency thereof or any other entity owned or controlled by GoP/autonomous body through any corrupt business practice.

Without limiting the generality of the foregoing, [name of Contractor] represents and warrants that it has fully declared the brokerage, commission, fees etc. paid or payable to anyone and not given or agreed to give and shall not give or agree to give to anyone within or outside Pakistan either directly or indirectly through any natural or juridical person, including its affiliate, agent, associate, broker, consultant, director, promoter, shareholder, sponsor or subsidiary, any commission, gratification, bribe, finder’s fee or kickback, whether described as consultation fee or otherwise, with the object of obtaining or inducing the procurement of a contract, right, interest, privilege or other obligation or benefit in whatsoever form from GoP/autonomous body, except that which has been expressly declared pursuant hereto.

[Name of Contractor] certifies that it has made and will make full disclosure of all agreements and arrangements with all persons in respect of or related to the transaction with GoP/autonomous body and has not taken any action or will not take any action to circumvent the above declaration, representation or warranty.

[Name of Contractor] accepts full responsibility and strict liability for making any false declaration, not making full disclosure, misrepresenting facts or taking any action likely to defeat the purpose of this declaration, representation and warranty. It agrees that any contract, right, interest, privilege or other obligation or benefit obtained or procured as aforesaid shall, without prejudice to any other rights and remedies available to GoP/autonomous body under any law, contract or other instrument, be voidable at the option of GoP/autonomous body.

Notwithstanding any rights and remedies exercised by GoP/autonomous body in this regard, [name of Contractor] agrees to indemnify GoP/autonomous body for any loss or damage incurred by it on account of its corrupt business practices and further pay compensation to GoP/autonomous body in an amount equivalent to ten time the sum of any commission, gratification, bribe, finder’s fee or kickback given by [name of Supplier] as aforesaid for the purpose of obtaining or inducing the procurement of any contract, right, interest, privilege or other obligation or benefit in whatsoever form from GoP/autonomous body.

Name of Employer: .....

Name of Contractor: .....

Signature: .....

Signature: .....

[Seal]

[Seal]



**BM -1**  
**APPENDIX-M TO BID**

**QUALIFICATION CRITERIA**

Qualification of Bidders shall be evaluated on the basis of mentioned criteria regarding the Bidder's financial soundness, experience record, personnel and equipment capabilities, in addition to fulfillment preliminary Scrutiny requirements.

Information supplied by the Bidders for the qualification must apply to the company/ firm, named on the statement only. The substitution of background information pertinent to qualification will not be considered for another company related to the applicant company through a "Group ownership. The Employer reserves the right to waive minor deviations, if they do not materially affect the capability of the Bidder to perform the Contract.

**A. Preliminary Scrutiny:**

Preliminary Scrutiny will be based on all the criteria given below. The Bidder failed in Preliminary Scrutiny shall be considered disqualified and its Technical Bid will not be evaluated any further.

SNO	Description	Annexure / Page No. of attached Document
1.	Bid is un-conditional, conditional bids shall be rejected.	
2.	<b>Bid Security</b> Bid Security as required in clause IB-15. Bid security would be submitted in ORIGINAL along with Technical Proposal.	
3.	<b>Active NTN</b> Bidder must be registered with FBR in Income Tax and must active taxpayer as per Federal Board of Revenue (FBR's) revenue Data base i-e Active Tax Payer List. (NTN)	
4.	<b>PEC Valid Registration</b> The bidder should have valid registration with Pakistan Engineering Council at least in Category of C-5 or above with specialization category CE-10.	

**B. Detailed Scrutiny**

Detailed Scrutiny will be based on all criteria given below.

SNO.	Description	Annexure / Page No. of attached Document
5.	Duly filled and signed Form of Bid.	
6.	<b>Company Registration</b> Documentary evidence of registration of company/ firm showing the status i.e. (i) Individual/ Sole Proprietorship, (ii) Associated of Persons, (iii) Pvt. Limited. Contact Details including address, Landline, Mobile, Fax numbers and Email address.	
7.	<b>Undertaking (As per Form – 6 attached)</b> The bidder is required to submit an undertaking on stamp paper of Rs.100/- as per format provided in Form –6.	
8.	<b>Registration with relevant Revenue Authority</b> The Bidder should also be registered with relevant / concerned Revenue Authority. If not registered, the 100% tax shall be deducted at source as per applicable law and credited to relevant account.	
9.	<b>Experience:</b> Minimum one work (construction/repair/ renovation/ maintenance) of cost Rs.20M or more each, executed during last seven years (Work order/ completion certificates to be attached).	



10.	<p><b>Financial Capability:</b> Available Financial Capability/Liquid Assets of Rs. 5.0 Million or above. (Bank statement of firm be submitted as evidence showing required balance at any one instant in the statement of last three months before date of publication of tender notice or available Bank Credit Line facility during same period).</p>	
11.	<p><b>Work Program:</b> Acceptance of the Proposed Work Program as given in Appendix -F to Bid or submission of Work Program proposed by the bidder with overall project duration as mentioned in the contract data. The Bidder shall submit methodology of work of items as mentioned in in Appendix -F</p>	
12.	<p><b>Technical Specifications</b> The offered FCU must comply with the minimum technical specification as specified in Appendix - Q to Bid. Therefore, the Bidder shall submit technical brochures of FCU. Further the Bidder shall also submit technical brochures of LED lights and Electrical Cables.</p>	



**BN-1**  
**Appendix-N to Bid**

**LIST OF RECOMMENDED  
MANUFACTURERS**

**Not applicable**



**BO-1**  
**Appendix-O to Bid**

**SPECIAL PROVISIONS & TECHNICAL  
SPECIFICATIONS**

**LED Lights Specifications**

The description of light fixtures is given in the bill of quantities, and stated on the drawings, and all relevant material is described in this Section. The determination of quality is based on certified photo-metric data covering the coefficient of utilization, light distribution curves, construction material, shape, finish, operation, etc.

The Contractor shall submit at least two samples of each and every light fixture specified and obtain approval of the Engineer before purchasing. The quality and finishes of the local make light fixtures (if mentioned in BOQ) shall be same as that of standard manufacturer. For any substitution the Engineer's approval is necessary.

All fixtures shall be finished in standard color schemes as mentioned in the manufacturer's catalogue for respective fixtures, unless specifically stated in the Specifications, Drawings or Bill of Quantities or directed by the Engineer.

The types of fixtures with manufacturer's catalogue reference are given on the fixture schedule and in bill of quantities. Equivalent fixture may be acceptable provided that the Contractor submits for review all necessary data indicating Polar Intensity Diagram, Quality Estimation Diagram, UGR diagram, Utilization Factor Table, Luminance Table and computer simulation files for DiaLUX or equivalent software to show that the fixture proposed are of the same type, construction and quality.

**APPLICABLE STANDARDS/CODES**

The latest editions of the following standards/codes shall be applicable to the material specified within the scope of this section:

IEC 62471	Light Emitting Diodes (LED)
IEC 62031	LED Modules for General Lighting - Safety Specifications
IEC 62612	Self-ballasted LED lamps for general lighting services with supply voltages > 50 V - Performance Requirements
IEC 62560	Self-ballasted LED-lamps for general lighting services by voltage > 50 V - Safety Specifications
CIE 84:1989	Measurement of luminous flux
IES LM-79-2008	Approved Method: Electrical and photometric measurements of solid-state lighting products
IES LM-80-2008	Approved Method: Measuring lumen maintenance of LED light sources
UL 8750	Standard for LED equipment for use in lighting products



Drawings

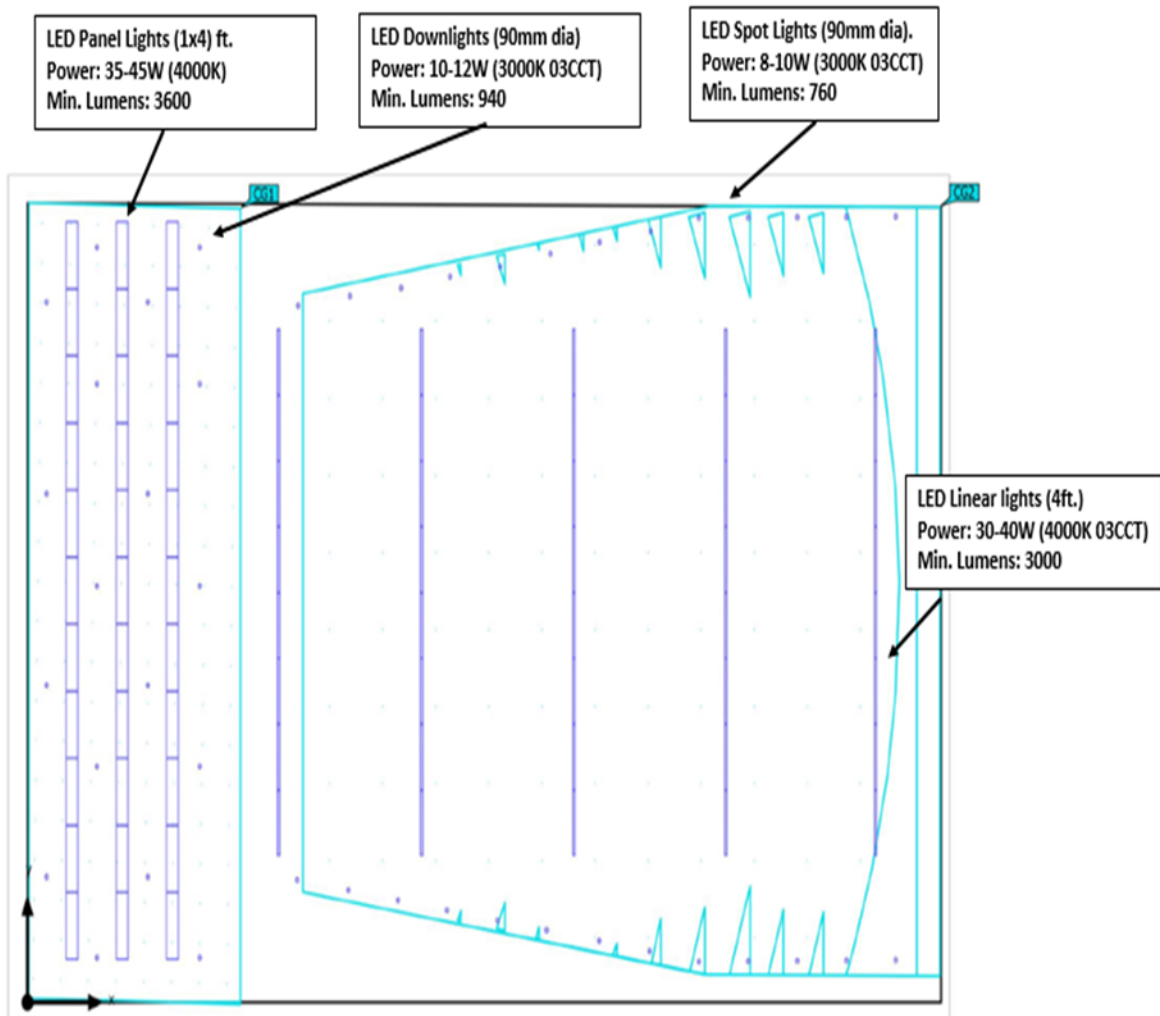

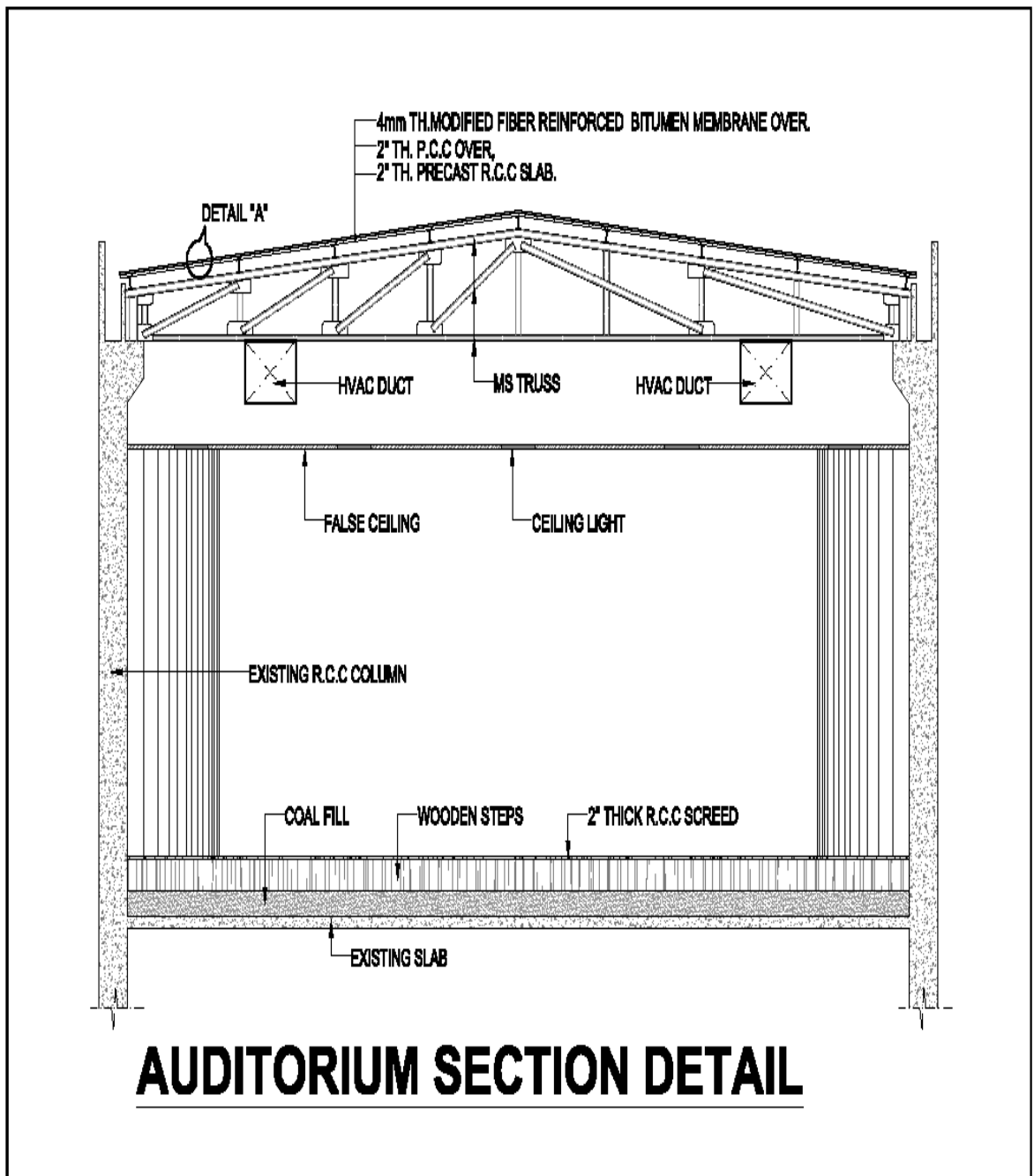



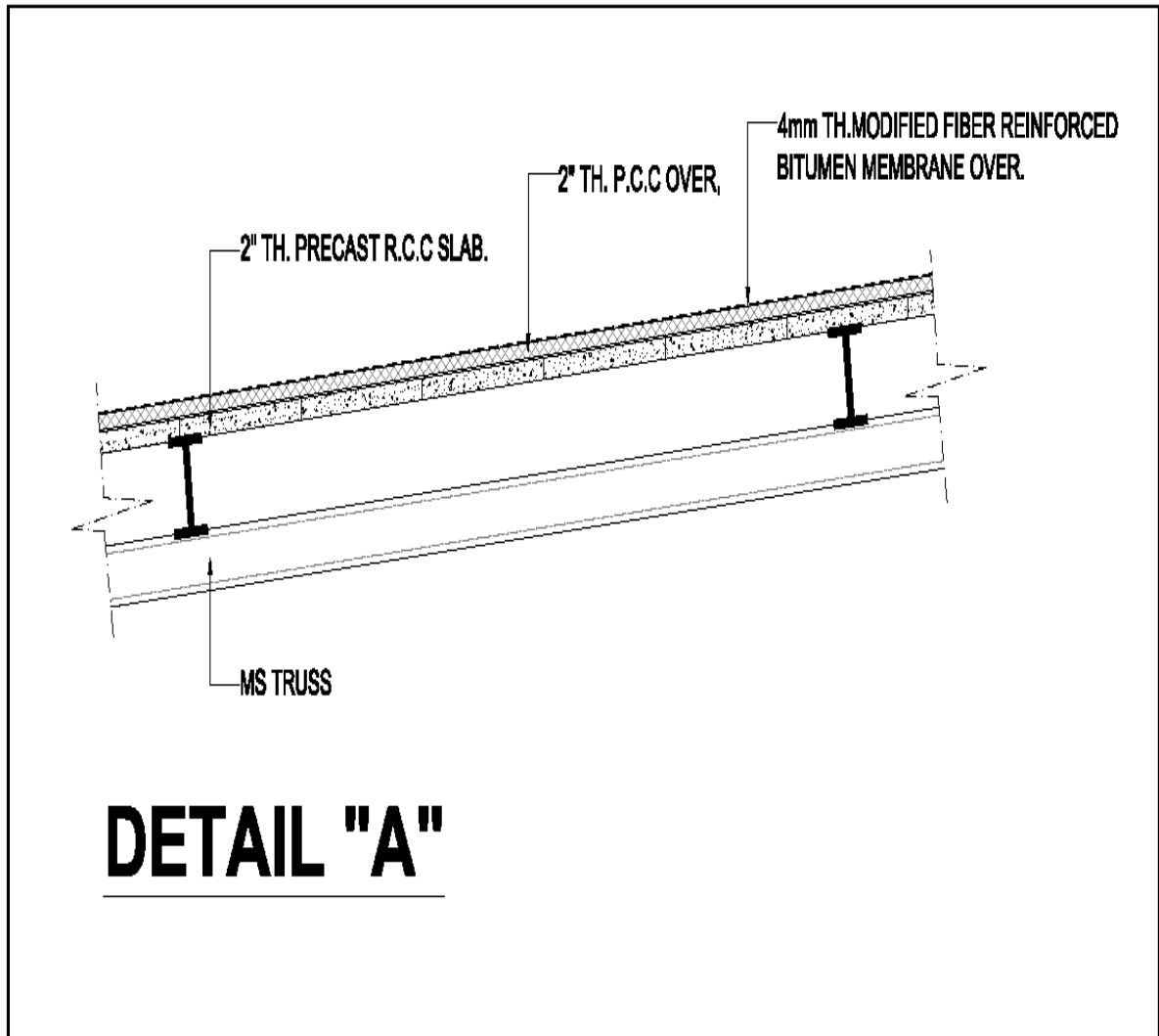

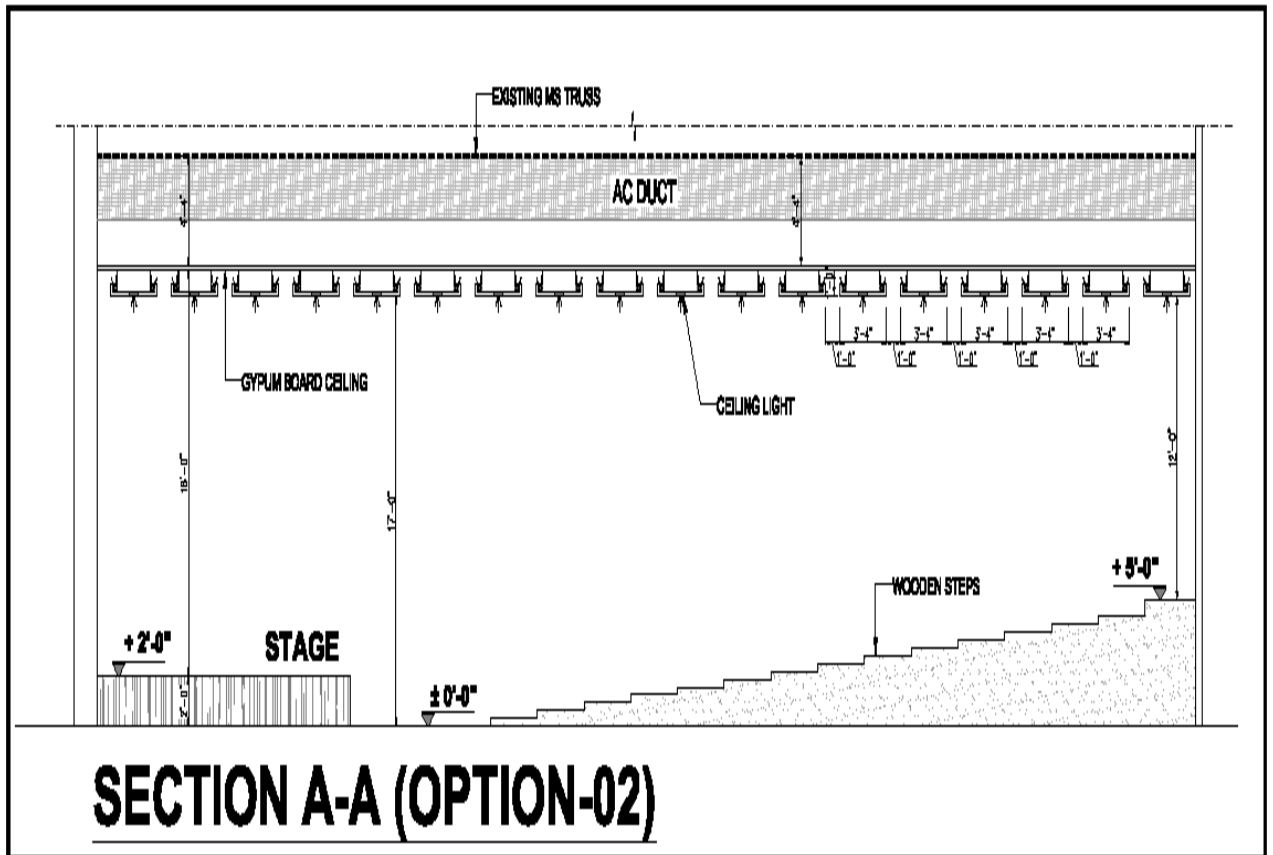

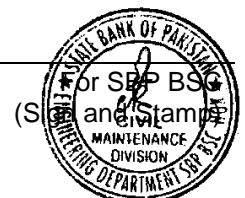
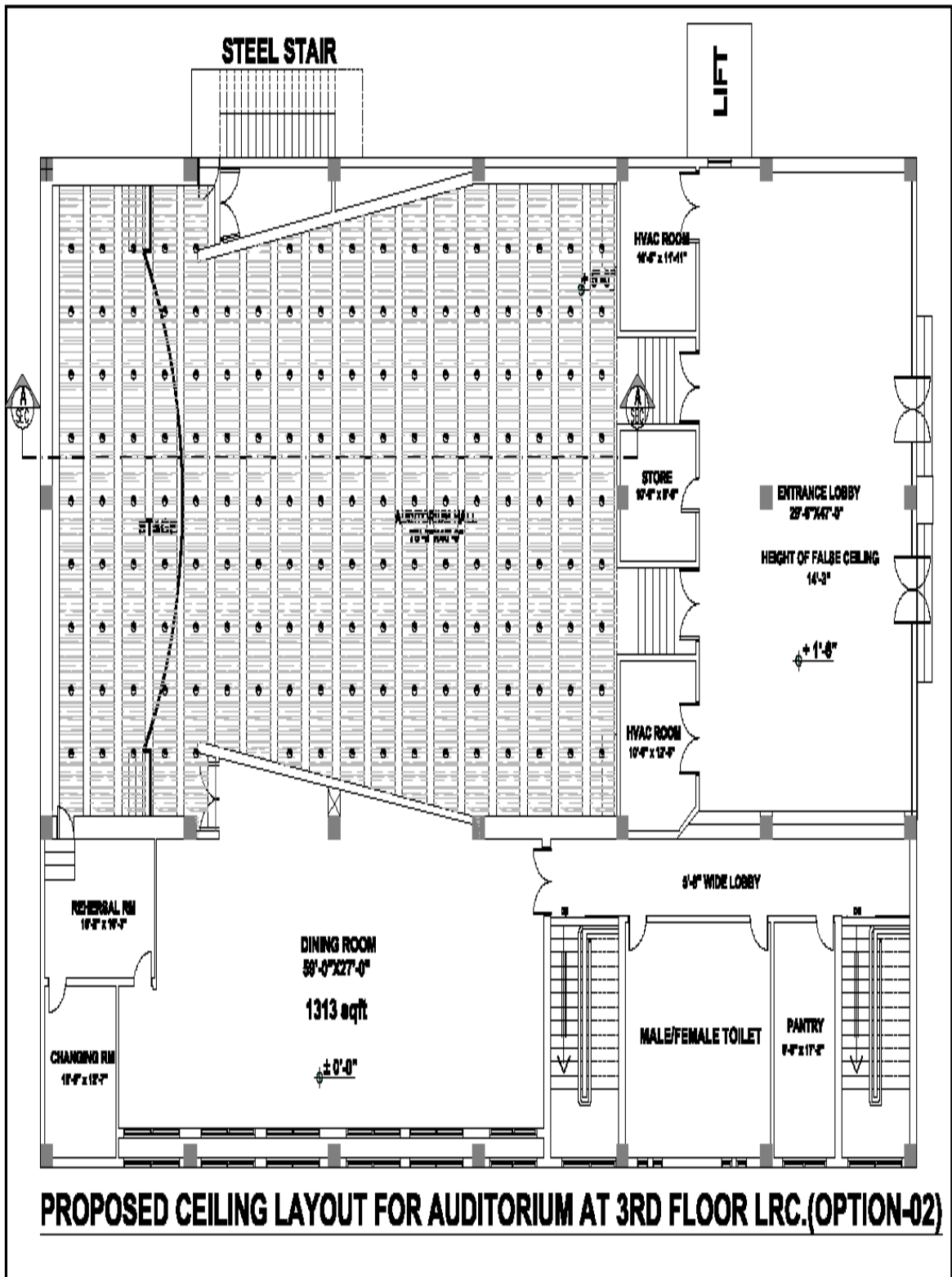

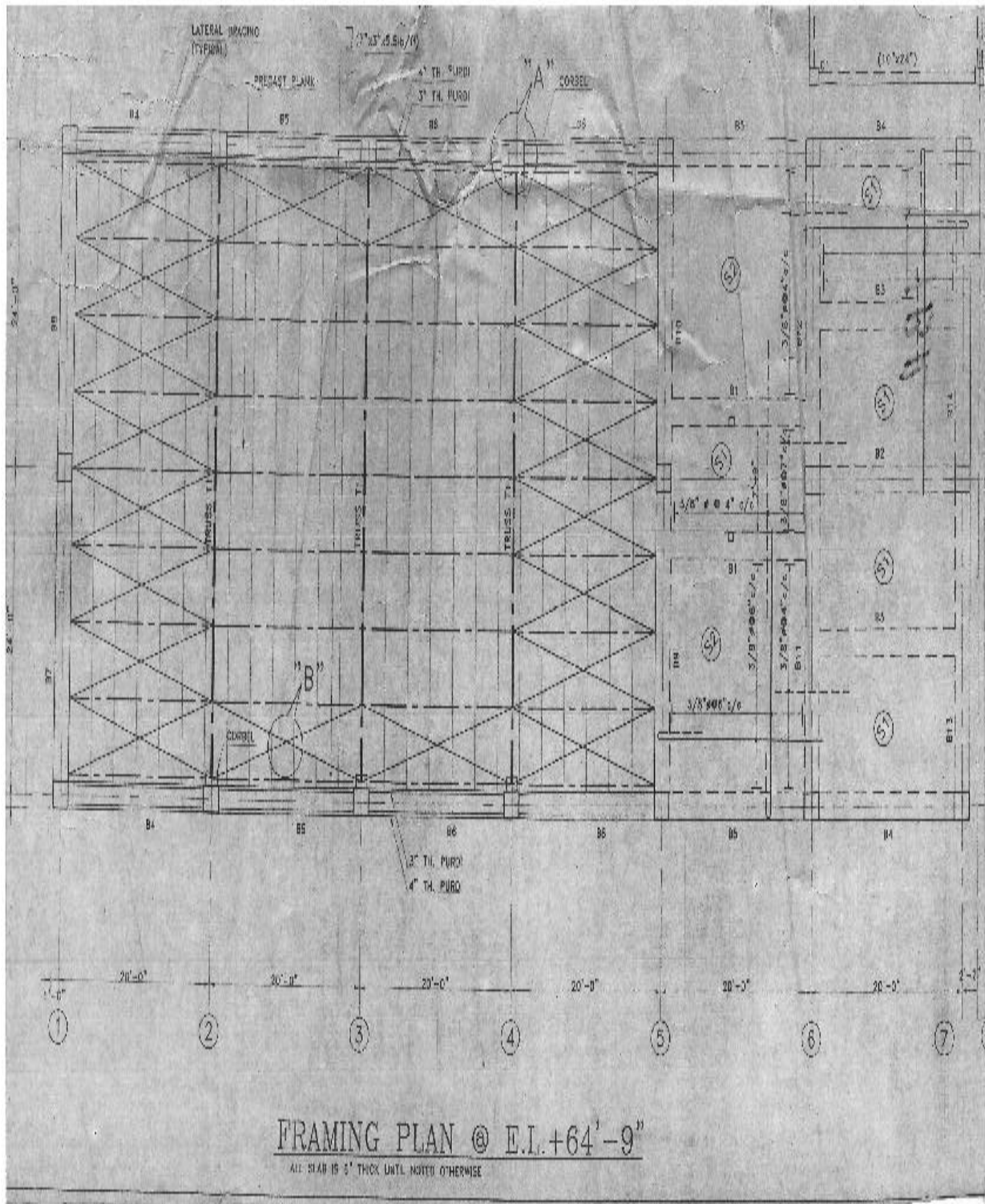

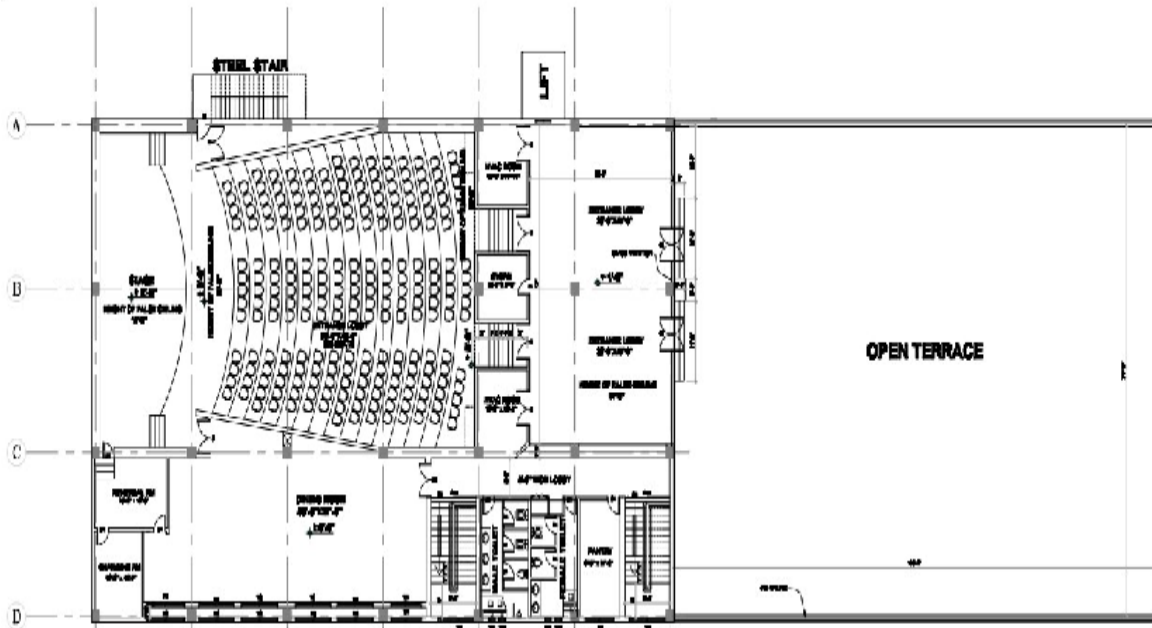

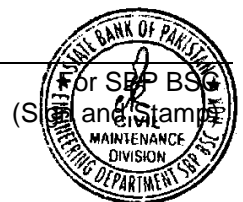
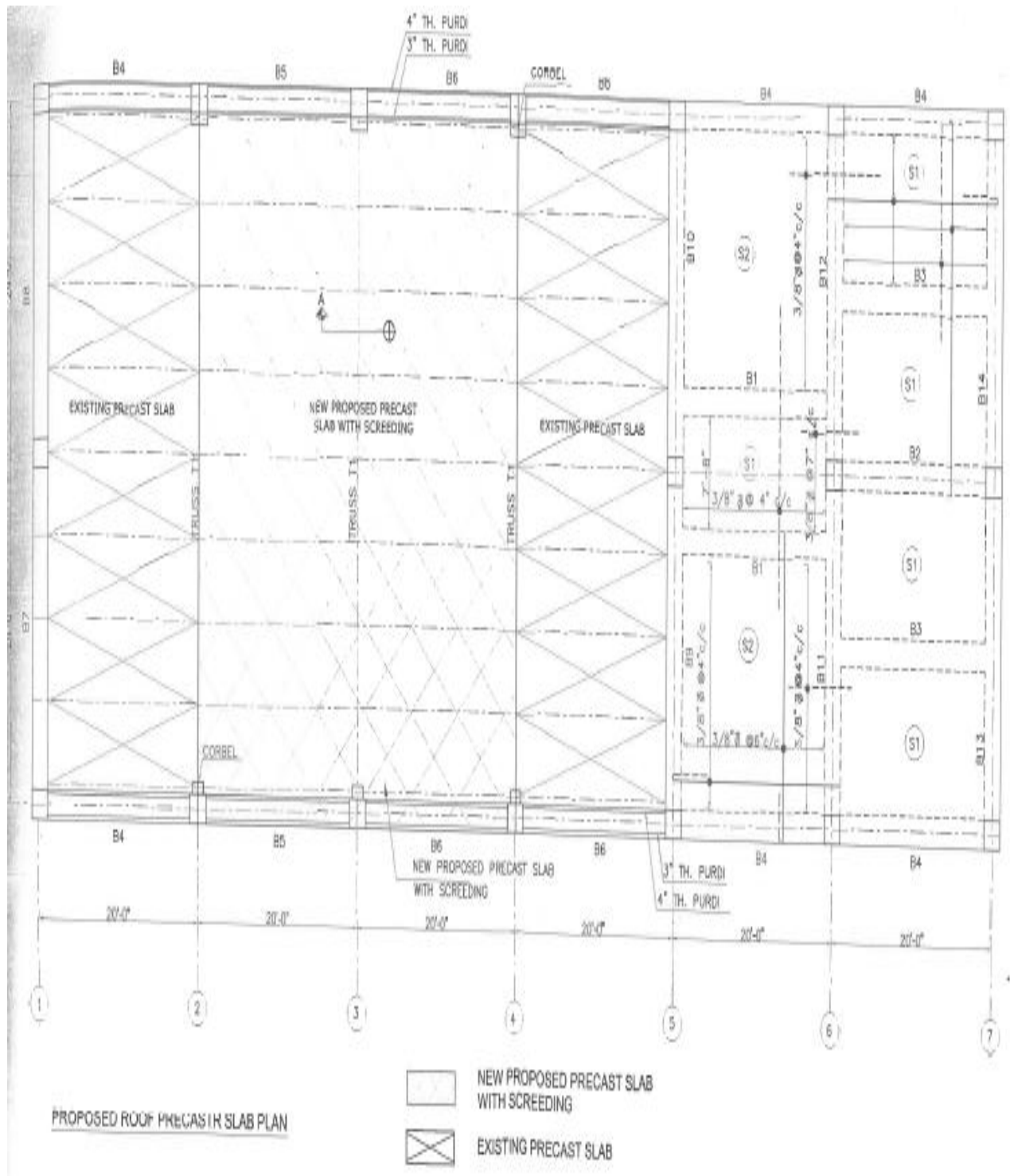

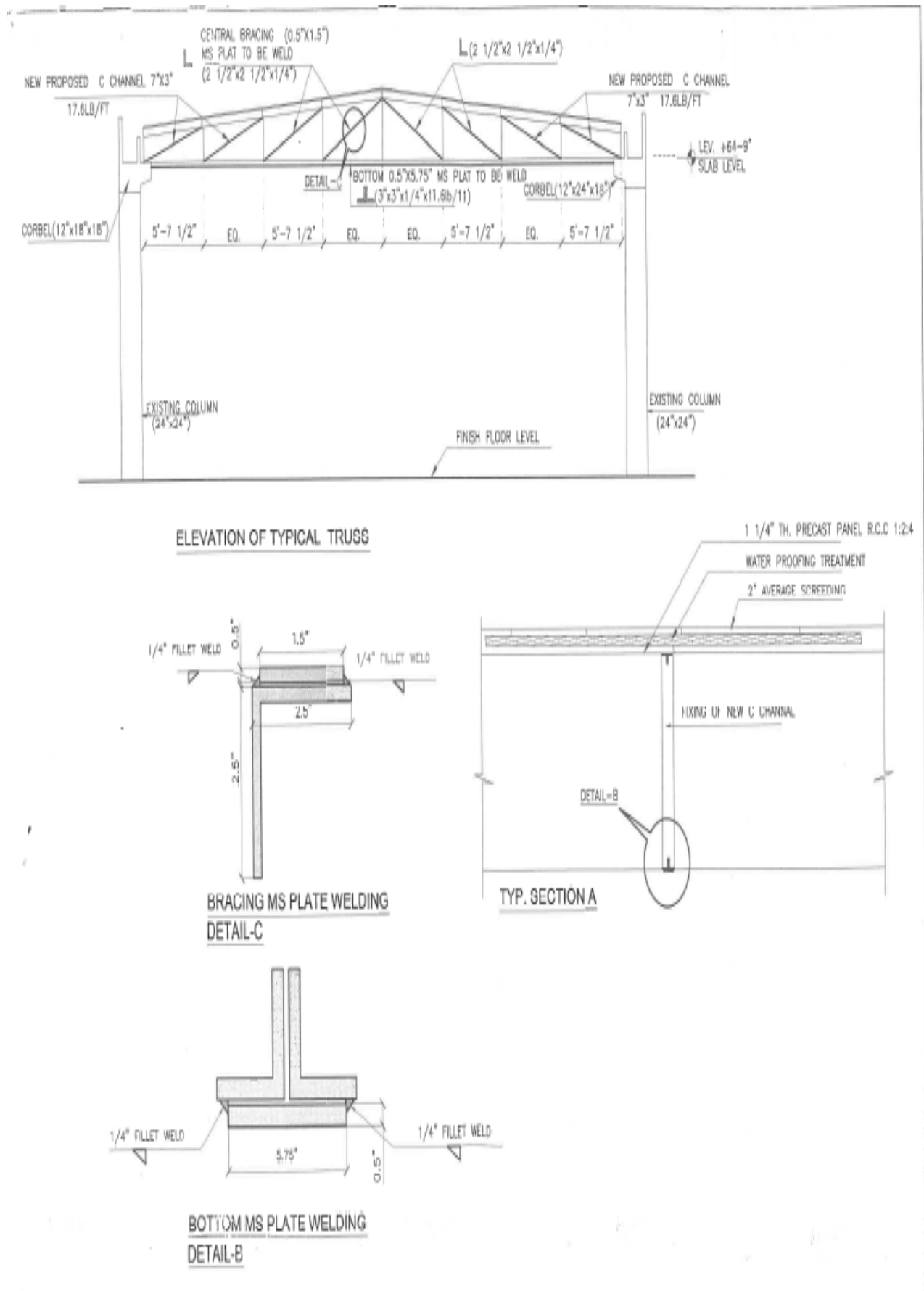

**BP-1**  
**Appendix-Q to Bid**

<b>2- TR - Wall Mounted Decorative type Fan Coil Unit</b>			
	<b>Description</b>	<b>Unit</b>	<b>Minimum Requirement</b>
1	Offered Brand Name		
2	Model No.		
3	Capacity	BTU/Hr	Not less than 22000 BTU/Hr
4	Chilled Water Flow	GPM	Not less than <b>5.0</b>
5	Supply air quantity	CFM	700
6	Plastic Body &Decorative	Should be Plastic body and Decorative Type	<input type="checkbox"/> Yes <input type="checkbox"/> No
7	Auto Restart Function	Should have Auto Restart Function	<input type="checkbox"/> Yes <input type="checkbox"/> No
8	Electric Power Supply		230 V, 50 HZ, Single Phase





# STANDARD FORMS



BS-1

**FORM OF BID SECURITY  
(BANK GUARANTEE)**

Security Executed on \_\_\_\_\_  
(Date)

Name of Surety with Address: \_\_\_\_\_  
(Scheduled Bank in Pakistan)

Name of Principal (Bidder) with Address \_\_\_\_\_  
\_\_\_\_\_

Penal Sum of Security Rupees. \_\_\_\_\_ (Rs. \_\_\_\_\_)

Bid Reference No: \_\_\_\_\_

KNOW ALL MEN BY THESE PRESENTS, that in pursuance of the terms of the Bid and at the request of the said Principal (Bidder) we, the Surety above named, are held and firmly bound unto

(hereinafter called the 'Employer') in the sum stated above for the payment of which sum well and truly to be made, we bind ourselves, our heirs, executors, administrators and successors, jointly and severally, firmly by these presents.

THE CONDITION OF THIS OBLIGATION IS SUCH, that whereas the Bidder has submitted the accompanying Bid dated \_\_\_\_\_ for \_\_\_\_\_  
\_\_\_\_\_ to the said Employer; and  
(Particulars of Bid)

WHEREAS, the Employer has required as a condition for considering said Bid that the Bidder furnishes a Bid Security in the above said sum from a Scheduled Bank in Pakistan or from a foreign bank duly counter-guaranteed by a Scheduled Bank in Pakistan, to the Employer, conditioned as under:

- (1) that the Bid Security shall remain in force up to and including the date 28 days after the deadline for validity of Bids as stated in the Instructions to Bidders or as it may be extended by the Employer, notice of which extension(s) to the Surety is hereby waived.
- (2) that the Bid Security of unsuccessful Bidders will be returned by the Employer after expiry of its validity or upon signing of the Contract Agreement; and
- (3) that in the event of failure of the successful Bidder to execute the proposed Contract Agreement for such work and furnish the required Performance Security, the entire said sum be paid immediately to the said Employer pursuant to Clause 15.6 of the Instruction to Bidders for the successful Bidder's failure to perform.

NOW THEREFORE, if the successful Bidder shall, within the period specified therefor, on the prescribed form presented to him for signature enter into a formal Contract with the said Employer in accordance with his Bid as accepted and furnish within twenty eight (28) days of his being requested to do so, a Performance Security with good and sufficient surety, as may be required, upon the form prescribed by the said Employer for the faithful performance and proper fulfilment of the said Contract or in the event of non-withdrawal of the said Bid within the time specified for its validity then this obligation shall be void and of no effect, but otherwise to remain in full force and effect.

For Bidder  
(Sign and Stamp)

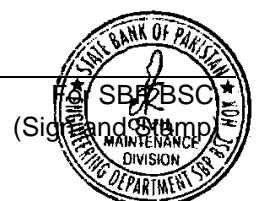

**BS-2**

PROVIDED THAT the Surety shall forthwith pay the Employer the said sum upon first written demand of the Employer (without cavil or argument) and without requiring the Employer to prove or to show grounds or reasons for such demand, notice of which shall be sent by the Employer by registered post duly addressed to the Surety at its address given above.

PROVIDED ALSO THAT the Employer shall be the sole and final judge for deciding whether the Principal (Bidder) has duly performed his obligations to sign the Contract Agreement and to furnish the requisite Performance Security within the time stated above, or has defaulted in fulfilling said requirements and the Surety shall pay without objection the said sum upon demand from the Employer forthwith and without any reference to the Principal (Bidder) or any other person.

IN WITNESS WHEREOF, the above bounden Surety has executed the instrument under its seal on the date indicated above, the name and seal of the Surety being hereto affixed and these presents duly signed by its undersigned representative pursuant to authority of its governing body.

**SURETY (Bank)**

WITNESS:

1. \_\_\_\_\_  
\_\_\_\_\_  
Name, CNIC No. Title & Address

2. \_\_\_\_\_  
\_\_\_\_\_  
Name, CNIC No. Title & Address

Signature \_\_\_\_\_  
Name \_\_\_\_\_  
Title \_\_\_\_\_  
Stamp/Seal:-----



**FORM OF PERFORMANCE SECURITY  
(Bank Guarantee)**

Guarantee No. \_\_\_\_\_  
Executed on \_\_\_\_\_  
Expiry date \_\_\_\_\_

[Letter by the Guarantor to the Employer]

Name of Guarantor (Bank) with address: \_\_\_\_\_

Name of Principal (Contractor) with address: \_\_\_\_\_

Penal Sum of Security (express in words and figures) \_\_\_\_\_ Letter  
of Acceptance No:- \_\_\_\_\_ Dated \_\_\_\_\_

KNOW ALL MEN BY THESE PRESENTS, that in pursuance of the terms of the Bidding Documents and above said Letter of Acceptance (hereinafter called the Documents) and at the request of the said Principal we, the Guarantor above named, are held and firmly bound unto the \_\_\_\_\_ (hereinafter called the Employer) in the penal sum of the amount stated above for the payment of which sum well and truly to be made to the said Employer, we bind ourselves, our heirs, executors, administrators and successors, jointly and severally, firmly by these presents.

THE CONDITION OF THIS OBLIGATION IS SUCH that whereas the Principal has accepted the Employer's above said Letter of Acceptance for \_\_\_\_\_ for the \_\_\_\_\_ (Name of Contract) (Name of Project).

NOW THEREFORE, if the Principal (Contractor) shall well and truly perform and fulfill all the undertakings, covenants, terms and conditions of the said Documents during the original terms of the said Documents and any extensions thereof that may be granted by the Employer, with or without notice to the Guarantor, which notice is, hereby, waived and shall also well and truly perform and fulfill all the undertakings, covenants terms and conditions of the Contract and of any and all modifications of said Documents that may hereafter be made, notice of which modifications to the Guarantor being hereby waived, then, this obligation to be void; otherwise to remain in full force and virtue till all requirements of Clause 49, Defects after Taking Over, of Conditions of Contract are fulfilled.

Our total liability under this Guarantee is limited to the sum stated above and it is a condition of any liability attaching to us under this Guarantee that the claim for payment in writing shall be received by us within the validity period of this Guarantee, failing which we shall be discharged of our liability, if any, under this Guarantee.

We, \_\_\_\_\_ (the Guarantor), waiving all objections and defenses under the Contract, do hereby irrevocably and independently guarantee to pay to the Employer without delay upon the Employer's first written demand without cavil or arguments and without requiring the Employer to prove or to show grounds or reasons for such demand any sum or sums up to the amount stated above, against the Employer's written declaration that the Principal has refused or failed to perform the obligations under the Contract which payment will be effected by the Guarantor to Employer's designated Bank & Account Number.

PROVIDED ALSO THAT the Employer shall be the sole and final judge for deciding whether the Principal (Contractor) has duly performed his obligations under the Contract or has defaulted in fulfilling said obligations and the Guarantor shall pay without objection any sum or sums up to the amount stated above upon first written demand from the Employer forthwith and without any reference to the Principal or any other person.

For Bidder  
(Sign and Stamp)

For \_\_\_\_\_  
(Sign and Stamp)  

IN WITNESS WHEREOF, the above-bounden Guarantor has executed this Instrument under its seal on the date indicated above, the name and corporate seal of the Guarantor being hereto affixed and these presents duly signed by its undersigned representative, pursuant to authority of its governing body.

\_\_\_\_\_  
Guarantor (Bank)

Witness:

1. \_\_\_\_\_  
\_\_\_\_\_  
Name, CNIC No. Title, & Address

2. \_\_\_\_\_  
\_\_\_\_\_  
Name, CNIC No. Title, & Address

Signature \_\_\_\_\_

Name \_\_\_\_\_

Title \_\_\_\_\_

\_\_\_\_\_  
Guarantor (Stamp/Seal)



CA-1

**FORM OF CONTRACT AGREEMENT**

THIS CONTRACT AGREEMENT (hereinafter called the "Agreement") made the \_\_\_\_\_ day of \_\_\_\_\_ 20\_\_ between \_\_\_\_\_

(hereafter called the "Employer" which expression shall include the successors, legal representatives and permitted assignees) of the one part and \_\_\_\_\_ of \_\_\_\_\_

(hereafter called the "Contractor" which

expression shall include the successors, legal representatives and permitted assignees) of the other part.

WHEREAS the Employer is desirous that certain Works, viz \_\_\_\_\_ should be executed by the Contractor and has accepted a Tender by the Contractor for the execution and completion of such Works and the remedying of any defects therein.

NOW this Agreement witnesseth as follows:

1. In this Agreement words and expressions shall have the same meanings as are respectively assigned to them in the Conditions of Contract hereinafter referred to.
2. The following documents after incorporating addenda, if any, except those parts relating to Instructions to Bidders shall be deemed to form and be read and construed as part of this Agreement, viz:
  - (a) The Contract Agreement;
  - (b) The Letter of Acceptance;
  - (c) The Bid;
  - (d) Special Stipulations (Appendix-A to Bid);
  - (e) The Particular Conditions of Contract – Part II;
  - (f) The General Conditions of Contract– Part I;
  - (g) Special Provisions
  - (h) The Appendices to Bid (B to N), (excluding Appendix-D to Bid);
  - (i) The Drawings;
  - (j) The Specifications, Technical Provisions;
  - (k) The Priced Bill of Quantities (rationalize and original); (Appendix-D to Bid)
  - (l) Performance Security.
  - (m) Addenda / Any Other Documents (if any) forming part of Bidding Documents
  - (n) Instruction to Bidders and Bidding Data
3. In consideration of the payments to be made by the Employer to the Contractor as hereinafter mentioned, the Contractor hereby covenants with the Employer to execute and complete the Works in conformity and in all respects with the provisions of the Contract.

For Bidder  
(Sign and Stamp)

Page 62 of 102

For \_\_\_\_\_  
(Sign and Stamp)



CA-2

- 4. The Employer hereby covenants to pay the Contractor, in consideration of the execution and completion of the Works as per provisions of the Contract, the Contract Price or such other sum as may become payable under the provisions of the Contract at the times and in the manner prescribed by the Contract.

IN WITNESS WHEREOF the parties hereto have caused this Agreement to be executed the day and year first before written in accordance with the respective laws.

**For and on behalf of Contractor**

Signature: \_\_\_\_\_

Name :- \_\_\_\_\_

Title :- \_\_\_\_\_

Signed, Sealed and Delivered in the presence of: \_\_\_\_\_

**Witness 01**

Signature: \_\_\_\_\_

Name :- \_\_\_\_\_

Title :- \_\_\_\_\_

Address :- \_\_\_\_\_

**Witness 02**

Signature: \_\_\_\_\_

Name :- \_\_\_\_\_

Title :- \_\_\_\_\_

Address :- \_\_\_\_\_

**For and on behalf of Employer**

Signature: \_\_\_\_\_

Name :- \_\_\_\_\_

Title :- \_\_\_\_\_

**Witness 01**

Signature: \_\_\_\_\_

Name :- \_\_\_\_\_

Title :- \_\_\_\_\_

Address :- \_\_\_\_\_

**Witness 02**

Signature: \_\_\_\_\_

Name :- \_\_\_\_\_

Title :- \_\_\_\_\_

Address :- \_\_\_\_\_



**MOBILIZATION ADVANCE GUARANTEE**

WHEREAS \_\_\_\_\_  
(hereinafter called the 'Employer') has entered into a Contract for (Particulars of Contract) with  
(hereinafter called the "Contractor").

AND WHEREAS, the Employer has agreed to advance to the Contractor, at the Contractor's request,  
an amount of Rupees \_\_\_\_\_  
(Rs \_\_\_\_\_) which amount shall be

advanced to the Contractor as per provisions of the Contract.

AND WHEREAS, the Employer has asked the Contractor to furnish Guarantee to secure the mobilization  
advance for the performance of his obligations under the said Contract.

AND WHEREAS, \_\_\_\_\_  
(Scheduled Bank in Pakistan) (hereinafter called the "Guarantor") at the request of the  
Contractor and in consideration of the Employer agreeing to make the above advance to the Contractor,  
has agreed to furnish the said Guarantee.

NOW, THEREFORE, the Guarantor hereby guarantees that the Contractor shall use the advance for the  
purpose of above mentioned Contract and if he fails and commits default in fulfilment of any of his  
obligations for which the advance payment is made, the Guarantor shall be liable to the Employer for  
payment not exceeding the aforementioned amount.

Notice in writing of any default, of which the Employer shall be the sole and final judge, on the part of the  
Contractor, shall be given by the Employer to the Guarantor, and on such first written dem and, payment  
shall be made by the Guarantor of all sums then due under this Guarantee without any reference to the  
Contractor and without any objection.

This Guarantee shall remain in force until the advance is fully adjusted against payments from the  
Interim Payment Certificates of the Contractor or until  
\_\_\_\_\_ whichever is earlier.  
(Date)

The Guarantor's liability under this Guarantee shall not in any case exceed the sum of Rupees  
\_\_\_\_\_ (Rs \_\_\_\_\_).

This Guarantee shall remain valid up to the aforesaid date and shall be null and void after the aforesaid  
date or earlier if the advance made to the Contractor is fully adjusted against payments from Interim  
Payment Certificates of the Contractor provided that the Guarantor agrees that the aforesaid period of  
validity shall be deemed to be extended if on the above mentioned date the advance payment is not fully  
adjusted.

**GUARANTOR**

- 1. Signature \_\_\_\_\_
- 2. Name \_\_\_\_\_
- 3. Title \_\_\_\_\_

**WITNESS**

1. \_\_\_\_\_  
(Name, CNIC No. Title & Address)

2. \_\_\_\_\_  
(Name, CNIC No. Title & Address)

\_\_\_\_\_  
Guarantor (Stamp/Seal)





**UNDERTAKING**

On separate non-judicial stamp paper

I / We \_\_\_\_\_ (the bidder) \_\_\_\_\_ do hereby solemnly affirm as under:

- a. That I / We have not been blacklisted, declared in-eligible or debarred by any organization / department for corrupt or fraudulent practices, or no failure to perform with SBP BSC in past.
- b. That I / We have obtained all information regarding all applicable Taxes and conform the requirements thereof at my / our own responsibility and have included the same in the quoted Bid Price. The quoted Bid Price also includes the cost of accepting the general risks / liabilities and obligations set forth or implied in the Contract. I / We understand and agree that the Employer will entertain no claim at any later stage on this account.
- c. That I / We have visited and examined the Site of Works and its surroundings and have obtained all information which is necessary for preparing the bid and entering into a Contract. I / We understand and agree that the Employer will entertain no claim at any later stage on this account.
- d. That I / We have never been involved in any litigation / arbitration / Blacklisting case.

**D E P O N E N T**



**A F F I D A V I T**  
**FOR SOLE PROPRIETERSHIP**

On Separate non-judicial stamp paper

I \_\_\_\_\_ S/D/O \_\_\_\_\_ bearing CNIC No. \_\_\_\_\_  
resident of \_\_\_\_\_ do hereby solemnly affirm  
and declare that I am the Sole Proprietor of the Firm M/s \_\_\_\_\_ having its  
registered office at \_\_\_\_\_, bearing Pakistan Engineering Council (PEC)  
registration No. \_\_\_\_\_ and as such, I am entirely responsible for all businesses carried out in the  
name of the Firm.

**D E P O N E N T**



**SECURITY BOND AGAINST RELEASE OF PAYMENT TO BE MADE BY EMPLOYER FOR ESTABLISHMENT OF LETTER OF CREDIT**

Bond No. \_\_\_\_\_  
Executed on \_\_\_\_\_  
Expiry date \_\_\_\_\_

[Letter by the Guarantor to the Employer]

Name of Guarantor with address: \_\_\_\_\_

Name of Principal (Contractor) with address: \_\_\_\_\_

Penal Sum of Security (express in words and figures) \_\_\_\_\_

Letter of Acceptance No. \_\_\_\_\_ Dated \_\_\_\_\_

KNOW ALL MEN BY THESE PRESENTS, that in pursuance of the terms of the Bidding Documents and clause No. \_\_\_\_\_ (hereinafter called as the Payment Terms) and at the request of the said Principal we, the Guarantor above named, are held and firmly bound unto the \_\_\_\_\_ (hereinafter called the Employer) in the penal sum of the amount stated above for the payment of which sum well and truly to be made to the said Employer, we bind ourselves, our heirs, executors, administrators and successors, jointly and severally, firmly by these presents.

THE CONDITION OF THIS OBLIGATION IS SUCH, that whereas the Principal has accepted terms of the Bidding Documents and the Payment Terms for the \_\_\_\_\_ (Name of Project).

NOW THEREFORE, if the Principal (Contractor) shall well and truly perform and fulfill all the undertakings, covenants, terms and conditions of the Payment Terms during the original terms of the said Documents and any extensions thereof that may be granted by the Employer, with or without notice to the Guarantor, which notice is, hereby, waived and shall also well and truly perform and fulfill all the undertakings, covenants terms and conditions of the Contract and of any and all modifications of said Documents that may hereafter be made, notice of which modifications to the Guarantor being hereby waived, then, this obligation to be void; otherwise to remain in full force and virtue till all requirements of the Payment Terms, of Conditions of Contract are fulfilled.

Our total liability under this Guarantee is limited to the sum stated above and it is a condition of any liability attaching to us under this Guarantee that the claim for payment in writing shall be received by us within the validity period of this Guarantee, failing which we shall be discharged of our liability, if any, under this Guarantee.

We, \_\_\_\_\_ (the Guarantor), waiving all objections and defences under the Contract, do hereby irrevocably and independently guarantee to pay to the Employer without delay upon the Employer's first written demand without cavil or arguments and without requiring the Employer to prove or to show grounds or reasons for such demand any sum or sums up to the amount stated above, against the Employer's written declaration that the Principal has refused or failed to perform the obligations under the Contract which payment will be effected by the Guarantor to Employer's designated Bank & Account Number.

PROVIDED ALSO THAT the Employer shall be the sole and final judge for deciding whether the Principal (Contractor) has duly performed his obligations under the Contract or has defaulted in fulfilling said obligations and the Guarantor shall pay without objection any sum or sums up to the amount stated above upon first written demand from the Employer forthwith and without any reference to the Principal or any other person.

IN WITNESS WHEREOF, the above-bounden Guarantor has executed this Instrument under its seal on the date indicated above, the name and corporate seal of the Guarantor being hereto affixed and these presents duly signed by its undersigned representative, pursuant to authority of its governing body.

	_____ Guarantor (Bank)
Witness:	
1. _____	Signature _____
_____	Name _____
Name, Title & Address	Title _____
2. _____	
_____	_____
Name, Title & Address	Corporate Guarantor (Seal)

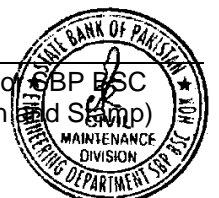

# GENERAL CONDITIONS OF CONTRACT



**PART-1****GENERAL CONDITIONS OF CONTRACT**

The General Conditions of Contract (Part-1) are based on the FIDIC “Conditions of Contract for Works of Civil Engineering Construction, Part-I General Conditions” Fourth Edition (1987) Reprinted in 1988 with editorial amendments, Reprinted in 1992 with further amendments, Reprinted 2011. These Conditions of Contract are published by the “FEDERATION OF INTERNATIONALE DES INGENIEURS-CONSEILS” (FIDIC), P.O. Box 86, CH 1000 Lausanne, 12-Chailly, SWITZERLAND.

The prospective Bidders may obtain copy of the above mentioned Conditions of Contract directly from Head Office of FIDIC, on the address indicated above against payment of their usual charges. However, the aforesaid FIDIC Conditions of Contract are available in the PEC Standard Form of Bidding Documents (Civil Works) which may be purchased from PEC Head office, Islamabad, for ready reference.



# PARTICULAR CONDITIONS OF CONTRACT



**PART II**  
**PARTICULAR CONDITIONS OF CONTRACT**

These Particular Conditions Of Contract - Part II are additions, deletions and amendments to General Conditions of Contract - Part I and shall be taken into consideration in interpreting or construing such clauses. Sub-Clause numbers, if similar as of Part-I, are amendments therein otherwise these are additional Clauses or Sub-Clauses thereto.

- Definitions**      **1.1**
- (a) (i) The “Employer” means Director Engineering, State Bank of Pakistan BSC, Head Office Karachi and shall mean to include the legal successors and any assignee of such person.
- (a) (iv) The “Engineer” means competent person to be nominated later by the Employer, and notified to the Contractor, to act in replacement of the Engineer.
- Provided always that except in cases of professional misconduct, the outgoing Engineer to formulate his certifications/ recommendations in relation to all outstanding matters, disputes and claims relating to the execution of the Works during his tenure.

Add the following paragraphs:

- (a) (vi) **“Employer’s Representative” is:**
- Any competent person appointed in writing by the Employer and shall take effect on delivery of such appointment to the Engineer and the Contractor. The Employer may from time to time delegate to the Employer’s Representative any of the duties and authorities vested in the Employer and may at any time revoke such delegation.
- Any communication given by the Employer’s Representative to the Engineer and the Contractor in accordance with such delegation shall have the same effect as though it had been given by the Employer.
- (a) (vii) “Bidder or Tenderer” means any person or persons, company, corporation or firm submitting a Bid or Tender.
- (b) (v) Add the following at the end of the paragraph:
- The word “Bill of Quantities” is synonymous with “Estimate including Premium”.
- (vi) Add the following at the end of the paragraph:
- The word “Tender” is synonymous with “Bid” and the word “Tender Documents” with “Bidding Documents”.

Add the following paragraph:

- (b) (ix) **“Programme”** means the programme to be submitted by the Contractor in accordance with Sub-Clause 14.1 and any approved revisions thereto.





(e) (i) Delete the text and substitute with the following:

**“Contract Price”** means the sum stated in the Letter of Acceptance as payable to the Contractor for the execution and completion of the Works subject to such additions thereto or deductions there from as may be made and remedying of any defects therein in accordance with the provisions of the Contract.

(iv) Add the following at the end of Paragraph:

“Price put to Bid” means the Quoted Price for the Works as provided in the Summary of Cost, Appendix-D to Bid.

**Engineer's  
Duties and  
Authority**

**2.1**

(b) With reference to Sub-Clause 2.1(b), the following provisions shall also apply;

The Engineer shall obtain the specific approval of the Employer before carrying out his duties in accordance with the following Clauses:

- i. Consenting to the sub-letting of any part of the Works under Sub-Clause 4.1 “Subcontracting”.
- ii. Certifying additional cost determined under Sub-Clause 12.2 “Not Foreseeable Physical Obstructions or Conditions”.
- iii. Any action under Clause 10 “Performance Security” and Clauses 21, 23, 24 & 25 “Insurance” of sorts.
- iv. Any action under Clause 40 “Suspension”.
- v. Any action under Clause 44 “Extension of Time for Completion.”
- vi. Any action under Clause 47 “Liquidated Damages for Delay”.
- vii. Issuance of “Taking Over Certificate” under Clause 48.
- viii. Issuing a Variation Order under Clause 51 except:
  - a. in an emergency\* situation, as stated here below, or
  - b. if such variation would increase the Contract Price by less than the amount stated in the Appendix-A to bid.
- ix. Fixing rates or prices under Clause 52.
- x. Release of Retention Money to the Contractor under Sub-Clause 60.3 “Payment of Retention Money”.
- xi. Issuance of “Final Payment Certificate” under Sub-Clause 60.8.
- xii. Issuance of “Defect Liability Certificate” under Sub-Clause 62.1.
- xiii. Any change in the ratios of Contract currency proportions and payments thereof under Clause 72 “Currency and Rate of Exchange”.

\* (If in the opinion of the Engineer an emergency occurs affecting the safety of life or of the Works or of adjoining property, the Engineer may, without relieving the Contractor of any of his duties and responsibilities under the Contract, instruct



the Contractor to execute all such work or to do all such things as may, in the opinion of the Engineer, be necessary to abate or reduce the risk. The Contractor shall forthwith comply with any such instruction of the Engineer. The Engineer shall determine an addition to the Contract Price, in respect of such instruction, in accordance with Clause 52 and shall notify the Contractor accordingly, with a copy to the Employer.)

- |                                       |            |   |
|---------------------------------------|------------|---|
| <b>Engineer's Representative</b>      | <b>2.2</b> | <p>Add the following paragraph at the end:</p> <p>“The Employer shall ensure that the Engineer’s Representative is a professional engineer as defined in the Pakistan Engineering Council Act 1975 (V of 1976).”</p> <p>Add the following Sub-Clauses 2.7 and 2.8:</p>  |
| <b>Engineer not Liable</b>            | <b>2.7</b> | <p>Approval, reviews and inspection by the Engineer of any part of the Works does not relieve the Contractor from his sole responsibility and liability for the supply of materials, plant and equipment for construction of the Works and their parts in accordance with the Contract and neither the Engineer's authority to act nor any decision made by him in good faith as provided for under the Contract whether to exercise or not to exercise such authority shall give rise to any duty or responsibility of the Engineer to the Contractor, any Subcontractor, any of their representatives or employees or any other person performing any portion of the Works.</p>   |
| <b>Replacement of the Engineer</b>    | <b>2.8</b> | <p>“If the Employer intends to replace the Engineer, the Employer shall, not less than 14 days before the intended date of replacement, give notice to the Contractor, of the name, address and relevant experience of the intended replacement Engineer. The Employer shall not replace the Engineer with a person against whom the Contractor raises reasonable objection by notice to the Employer, with supporting particulars.”</p>  |
| <b>Language(s) and Law</b>            | <b>5.1</b> | <p>a. The Contract Documents shall be drawn up in the English language.</p> <p>b. The Contract shall be subject to the Laws of Islamic Republic of Pakistan.</p>  |
| <b>Priority of Contract Documents</b> | <b>5.2</b> | <p>The Sub-Clause has been amended as under:</p> <p>The several documents forming the Contract are to be taken as mutually explanatory of one another, but in case of ambiguities or discrepancies the same shall be explained and adjusted by the Engineer who shall thereupon issue to the Contractor instructions thereon and in such event, unless otherwise provided in the Contract, the priority of the documents forming the Contract shall be as follows:</p> <ol style="list-style-type: none"> <li>(1) The Contract Agreement;</li> <li>(2) The Letter of Acceptance;</li> <li>(3) The completed Form of Bid;</li> <li>(4) Addenda (if any);</li> <li>(5) Special Stipulations (Appendix-A to Bid);</li> <li>(6) The Particular Conditions of Contract – Part II;</li> <li>(7) The General Conditions of Contract – Part I;</li> <li>(8) The Specifications – Special Provisions;</li> <li>(9) The completed Appendices to Bid (B to N), (excluding Appendix-D to Bid);</li> <li>(10) The Priced Bill of Quantities; (Appendix-D to Bid);</li> </ol> |



- (11) The Drawings;
- (12) The Specifications, Technical Provisions;
- (13) Any other document forming part of the Contract by reference

In case of discrepancies between drawings, those of larger scale shall govern unless they are superseded by a drawing of later date regardless of scale. All Drawings and Specifications shall be interpreted in conformity with the Contract and these Conditions. Addendum, if any, shall be deemed to have been incorporated at the appropriate places in the documents forming the Contract.

Add the following Sub-Clauses 6.6 and 6.7:

- |  |             |   |
|--|-------------|---|
| <b>Shop Drawings</b>                         | <b>6.6</b>  | The Contractor shall submit to the Engineer for review 2 copies of all shop and erection drawings applicable to this Contract as per provision of relevant Sub-Clause of the Contract.<br><br>Review and approval by the Engineer shall not be construed as a complete check but will indicate only that the general method of construction and detailing is satisfactory and that the Engineer's review or approval shall not relieve the Contractor of any of his responsibilities under the Contract.  |
| <b>As-Built Drawings</b>                     | <b>6.7</b>  | At the completion of the Works under the Contract, the Contractor shall furnish to the Engineer 2 copies and one reproducible of all drawings amended to comply with the Works as built. The price of such Drawings shall be deemed to be included in the Contract Price.   |
| <b>Contractor's General Responsibilities</b> | <b>8.1</b>  | Add the following under the sub-clause:<br><br>SBP BSC will provide access of Service Provider and Service Provider's employee(s) after verification and clearance by the police or other investigation agency as per SBP BSC Security Protocol, to all concerned parts of the buildings/ Premises where Services are to be provided under the Contract.  |
| <b>Contract Agreement</b>                    | <b>9.1</b>  | The Contract Agreement, Performance Security, Insurance Policies / Bonds and other Bond/Guarantees/Sureties / stamp duty shall be prepared and completed at the cost of the Contractor. The Contractor shall prepare two (2) copies of the Contract Document (including all the volumes / documents listed in the Contract Agreement) along-with copies of all the bonds/Guarantees/Sureties, at his cost and shall submit the same to the Employer.  |
| <b>Performance Security</b>                  | <b>10.1</b> | Delete the text and substitute with the following:<br><br>The Contractor shall obtain and provide to the Employer a Performance Security in the prescribed Form annexed to these Bidding / Contract Documents. The said security shall be furnished to the Employer by the Contractor within twenty-eight (28) days after the receipt of Letter of Acceptance. The Performance Security shall be of an amount equal to ten percent (10%) of the Contract Price stated in the Letter of Acceptance.<br><br>Performance Security valid till expiration of Defect Liability Period is required to be submitted in the shape of Pay order/ Demand Draft/ Deposit at call /Bank Guarantee from any Scheduled Bank in Pakistan or from a bank located outside Pakistan duly counter-guaranteed by a Scheduled Bank in Pakistan or Insurance Guarantee from any insurance company with AA rating by PACRA / JCR. |



The amount in the form of Pay Order, Demand Draft or Deposit at call will be encashed by the Employer upon submission of Performance Security.

Notwithstanding anything contained in the Contract and / or applicable law, Performance Security shall be forfeited if the Contractor fails to perform the Contract.

- Period of Validity of Performance Security** 10.2 Delete the text and substitute with the following:
- The Performance security shall be valid until the Contractor has executed and completed the Works and remedied any defects therein in accordance with the Contract. No claim shall be made against such security after the issue of the Defect Liability Certificate in accordance with Sub-Clause 62.1. One half of the such security in shape of insurance guarantee/ bond shall be returned to the Contractor within 14 days of the issue of Taking-Over Certificate, while the other half in shape of Pay order/ Demand Draft/ Deposit at call /Bank Guarantee shall be returned to the Contractor within 14 days of the issue of the Defects Liability Certificate. The performance security of equivalent amount shall be valid until the periods mentioned hereinabove
- Add the following Sub-Clause 10.4:
- Performance Security Binding on Variations and Changes** 10.4 The Performance Security shall be binding irrespective of changes in the quantities or variations in the Works or extensions in Time for Completion of the Works which are granted or agreed upon under the provisions.
- Not Foreseeable Physical Obstructions or Conditions** 12.2 Delete the text and substitute with the following:
- If, however, during the execution of the Works the Contractor encounters physical obstructions or physical conditions, other than climatic conditions on the Site, which obstructions or conditions were, in his opinion, not foreseeable by an experienced contractor, the Contractor shall forthwith give notice thereof to the Engineer, with a copy to the Employer. On receipt of such notice, the Engineer shall if in his opinion such obstructions or conditions could not have been reasonably foreseen by an experienced contractor, after due consultation with the Employer and the Contractor, determine any extension of time to which the Contractor is entitled under Clause 44, and shall notify the Contractor accordingly, with a copy to the Employer. Such determination shall take account of any instruction which the Engineer may issue to the Contractor in connection therewith, and any proper and reasonable measures acceptable to the Engineer which the Contractor may take in the absence of specific instructions from the Engineer.
- Programme to be Submitted** 14.1 The Sub-Clause has been amended as under:
- The Contractor shall prepare and submit the program of the work acceptable to the Engineers with in twenty-eight (28) days from the receipt of Letter of Acceptance for agreement of the Engineer and approval of the Employer. This program shall be prepared in accordance with the suggested program of works defined in Appendix–E to Bid and shall identify and highlight those activities which are on the critical path.
- The time schedule may be adjusted from time to time but the contractual completion date shall remain un-changed in accordance with the Bid



documents unless extensions of time are approved in accordance with the contract.

The programme should be computerized. Progress reporting by the Contractor should be supported, on a monthly basis with an update analysis of the progress including a statement on items, which are or are to become critical to the progress of the Work, along with the proposal on how the Contractor intends to alleviate the situation. Programme should include complete sequence of activities. Programme to be Primavera/MS Excel based and updated with actual progress continually.

**Cash Flow Estimate to be Submitted**

- 14.3** The detailed Cash Flow Estimate shall be submitted within twenty eight (28) days from the date of receipt of Letter of Acceptance.

Add the following Sub-Clause 14.5:

**Detailed Programme and Monthly Progress Report**

- 14.5**
- a. For purposes of Sub-Clause 14.1, the Contractor shall submit to the Engineer detailed programme for the following:
    1. Execution of Works;
    2. Labour Employment;
    3. Material Procurement;
    4. Schedules for submittals of shop drawings/bar-bending schedule, samples of material/literature for approval; and
    5. Other details as required by the Engineer.
  - b. During the period of the Contract, the Contractor shall keep a daily record of the work progress, which shall be made available to the Engineer as and when requested. The daily record shall include particulars of weather conditions, number of men working, deliveries of materials, quantity, location and assignment of Contractor's equipment.

Add the following Sub-Clauses 15.2 and 15.3:

**Language Ability of Contractor's Representative**

- 15.2** The Contractor's authorised representative shall be fluent in the English language. Alternately an interpreter with ability of English language shall be provided by the Contractor on full time basis.

**Contractor's Representative**

- 15.3** The Contractor's authorized representative and his other professional engineers working at site shall register themselves with the Pakistan Engineering Council.

The Contractor's authorized representative at Site shall be authorized to exercise adequate administrative and financial powers on behalf of the Contractor so as to achieve completion of the Works as per the Contract.

Add the following Sub-Clauses 16.3 and 16.4:

**Language Ability of Superintending Staff of Contractor**

- 16.3** A reasonable proportion of the Contractor's superintending staff shall have a working knowledge of the English language. If the Contractor's superintending staffs is not fluent in English language, the Contractor shall make competent interpreters available during all working hours in a number deemed sufficient by the Engineer.

**Employment of Local Personnel**

- 16.4** The Contractor is encouraged, to the extent practicable and reasonable, to employ staff and labour from sources within Pakistan.



Add the following Sub-Clauses 19.3 and 19.4:

**Safety Precautions 19.3** In order to provide for the safety, health and welfare of persons, and for prevention of damage of any kind, all operations for the purposes of or in connection with the Contract shall be carried out in compliance with the Safety Requirements of the Government of Pakistan with such modifications thereto as the Engineer may authorise or direct and the Contractor shall take or cause to be taken such further measures and comply with such further requirements as the Engineer may determine to be reasonably necessary for such purpose.

The Contractor shall make, maintain and submit reports to the Engineer concerning safety, health and welfare of persons and damage to property, as the Engineer may from time to time prescribe.

**Lighting Work at Night 19.4** In the event of work being carried out at night, the Contractor shall at his own cost, provide and maintain such good and sufficient light as will enable the work to proceed satisfactorily and without danger. The approaches to the Site and the Works where the night-work is being carried out shall be sufficiently lighted. All arrangement adopted for such lighting shall be to the satisfaction of the Engineer's Representative.

**Employer's Risks 20.4** The Employer's risks are:  
Delete the text and substitute with the following:

- a. insofar as they directly affect the execution of the Works in Pakistan:
  - i. war and hostilities (whether war be declared or not), invasion, act of foreign enemies,
  - ii. rebellion, revolution, insurrection, or military or usurped power, or civil war,
  - iii. ionizing radiations, or contamination by radioactivity from any nuclear fuel, or from any nuclear waste from the combustion of nuclear fuel, radioactive toxic explosive or other hazardous properties of any explosive nuclear assembly or nuclear component thereof,
  - iv. pressure waves caused by aircraft or other aerial devices travelling at sonic or supersonic speeds,
  - v. riot, commotion or disorder, unless solely restricted to the employees of the Contractor or of his Subcontractors and arising from the conduct of the Works;
- b. loss or damage due to the use or occupation by the Employer of any Section or part of the Permanent Works, except as may be provided for in the Contract.
- c. loss or damage to the extent that it is due to the design of the Works, other than any part of the design provided by the Contractor or for which the Contractor is responsible; and
- d. any operation of the forces of nature (insofar as it occurs on the Site) which an experienced contractor:-
  - i. could not have reasonably foreseen, or
  - ii. could reasonably have foreseen, but against which he could not reasonably have taken at least one of the following measures:-
    - a. prevent loss or damage to physical property from occurring by taking appropriate measures, or
    - b. insure against



**Insurance of Works and Contractor's Equipment**

**21.1** The Sub-Clause is amended as under:

Contractor is bound to provide all the below mentioned insurance policies for the persons, works and equipment, etc. on the Contract.

(a) General Requirements

Notwithstanding the responsibilities of the Contractor for indemnities and insurance as described hereunder, the Contractor before commencing work on Site, must discuss fully with the Engineer & Employer the Insurance coverage provided by each under any general policies which are to be applied to this Contract to ensure that there are no contingencies left uncovered and to reduce, as far as practicable, duplication of coverage. Should any areas of possible damage or loss be discovered that are not covered by definition of responsibilities set out in these conditions, the addition or reduction in premiums required to give such insurance coverage will be paid by the Contractor and the policies obtained by the mutual agreement of the Employer and the Contractor.

All payments will be in Pakistan Rupees required to replace the damaged items. The Contractor shall be responsible for deductibles and losses not covered by insurance. An insurance loss shall not affect the Employer's or Contractor's rights and obligations under the Contract.

(b) The Contractor shall include the following insurances:

**The Works**

Amount of Cover: The sum stated in Letter of Acceptance plus fifteen percent 15%.

**Contractor 's equipment ( If required by Contractor)**

Amount of Cover: Full replacement Cost

**Injury to Person and Damaged to Property including Third Party Insurance**

Amount of Cover:

- I. As per workmen compensation act
- II. Contractor's all Risk including Third party
- III. Damage to Employer's Property - The sum stated in Letter of Acceptance

Cost of compliance with the requirements of this Sub-Clause and providing all insurance policies shall be borne by the Contractor.

**Scope of Cover 21.2** The Sub-Clause is amended as under:

"The insurance in paragraphs (a) and (b) of Sub-Clause 21.1 shall be in the joint names of the Contractor and the Employer and shall cover:

- (a) the Employer and the Contractor against all loss or damage from whatsoever cause arising, other than as provided in Sub-Clause 21.4, from the first working day after the Commencement Date until the date of issue of the relevant Taking-Over Certificate in respect of the Works or any Section or part thereof as the case may be, and
- (b) the Contractor for his liability:
  - (i) during the Defects Liability Period for loss or damage arising from a cause occurring prior to the commencement of the Defects Liability Periods, and



(ii) for loss or damage occasioned by the Contractor in the course of any operations carried out by him for the purpose of complying with his obligations under Clauses 49 and 50.

(c) It shall be the responsibility of the Contractor to notify the insurer of any change in the nature and extent of the Works and to ensure the adequacy of the insurance coverage at all times during the currency of the Contract.

- Exclusions 21.4** The Sub-Clause has been amended as under:  
There shall be no obligation for the insurances in Sub-Clause 21.1 to include loss or damage caused by the risks listed under Sub-Clause 20.4 paras (a) (i) to (iv).
- Evidence and Terms of Insurances 25.1** The Sub-Clause has been amended as under:  
The Contractor shall provide evidence to the Employer as soon as practical but in any case prior to the start of the work at site that the insurances required under the Contract have been affected and shall provide the insurance policies to the Employer. When providing such evidence and such policies to the Employer, the Contractor shall notify the Engineer of so doing. Such insurance policies shall be consistent with the general terms agreed prior to the issue of the Letter of Acceptance. The Contractor shall effect all insurances for which he is responsible with insurers and in terms approved by the Employer.  
The Contractor shall also submit in original the receipts of all the premiums paid by the Contractor in connection with the above insurances.  
Add the following Sub-Clause 25.5:
- Insurance Companies 25.5** The Contractor shall be obliged to place insurances relating to the Contract including, but not limited to, the insurances referred to in Clauses 21, 23 and 24 with Insurance Company having AA rating of PACRA / JCR.  
Costs of such insurances shall be borne by the Contractor.  
Add the following Sub-Clause 31.3:
- Co-operation with other Contractors 31.3** During the execution of the Works, the Contractor shall co-operate fully with other contractors working for the Employer at and in the vicinity of the Site and also shall provide adequate precautionary facilities not to make himself a nuisance to local residents/Bank Operations and and other Contractors.  
Add the following Sub-Clauses 34.2 to 34.12:
- Rates of Wages and Conditions of Labour 34.2** The Contractor shall pay rates of wages and observe conditions of labour not less favourable than those established for the trade or industry where the work is carried out. In the absence of any rates of wages or conditions of labour so established, the Contractor shall pay rates of wages and observe conditions of labour which are not less favourable than the general level of wages and conditions observed by other employers whose general circumstances in the trade or in industry in which the Contractor is engaged are similar.





- Employment of Persons in the Service of Others** 34.3 The Contractor shall not recruit his staff and labour from amongst the persons in the services of the Employer or the Engineer; except with the prior written consent of the Employer or the Engineer, as the case may be.
- Housing for Labour** 34.4 Establishment of Camp and Housing facility within the premises of SBP BSC Head Office Karachi is not allowed. Contractor shall arrange for housing of its staff at his own cost.
- Health and Safety** 34.5 Due precautions shall be taken by the Contractor, and at his own cost, to ensure the safety of his staff and labour at all times throughout the period of the Contract. The Contractor shall further ensure that suitable arrangements are made for the prevention of epidemics and for all necessary welfare and hygiene requirements.
- Epidemics** 34.6 In the event of any outbreak of illness of an epidemic nature, the Contractor shall comply with and carry out such regulations, orders and requirements as may be made by the Government, or the local medical or sanitary authorities, for purpose of dealing with and overcoming the same.
- Supply of Water** 34.7 The Contractor shall, so far as is reasonably practicable, having regard to local conditions, provide on the Site, to the satisfaction of the Engineer or his representative, adequate supply of drinking and other water for the use of his staff and labour. Quality of drinking water should be in compliance with WHO standards for drinking water.
- Alcoholic Liquor or Drugs** 34.8 The Contractor shall not, otherwise than in accordance with the Statutes, Ordinances and Government Regulations or Orders for the time being in force, import, sell, give, barter or otherwise dispose of any alcoholic liquor or drugs, or permit or suffer any such importation, sale, gift, barter or disposal by his Subcontractors, agents, staff or labour.
- Arms and Ammunition** 34.9 The Contractor shall not give, or otherwise dispose of to any person or persons, any arms or ammunition of any kind or permit or suffer the same as aforesaid.
- Festivals and Religious Customs** 34.10 The Contractor shall in all dealings with his staff and labour have due regard to all recognised festivals, days of rest and religious and other customs.
- Disorderly Conduct** 34.11 The Contractor shall at all times take all reasonable precautions to prevent any unlawful, riotous or disorderly conduct by or amongst staff and labour and for the preservation of peace and protection of persons and property in the neighbourhood of the Works against the same.
- Compliance by Subcontractors** 34.12 The Contractor shall be responsible for compliance by his Subcontractors of the provisions of this Clause.
- Add the following Sub-Clauses 35.2 and 35.3:
- Records of Safety and Health** 35.2 The Contractor shall maintain such records and make such reports concerning safety, health and welfare of persons and damage to property as the Engineer may from time to time prescribe.



<b>Reporting of Accidents</b>	<b>35.3</b>	The Contractor shall report to the Engineer details of any accident as soon as possible after its occurrence. In the case of any fatality or serious accident, the Contractor shall, in addition, notify the Engineer immediately by the quickest available means.
		Add the following Sub-Clause 36.6:
<b>Use of Pakistani Materials and Services</b>	<b>36.6</b>	The Contractor shall, so far as may be consistent with the Contract, make the maximum use of materials, supplies, plant and equipment indigenous to or produced or fabricated in Pakistan and services, available in Pakistan provided such materials, supplies, plant, equipment and services shall be of required standard.
<b>Commencement of Works</b>	<b>41.1</b>	The Sub-Clause has been amended as under:  The Contractor shall commence the Works on Site within the period named in Appendix – A to Bid from the date of receipt by him from the Engineer of a written Notice to Commence. Thereafter, the Contractor shall proceed with the Works with due expedition and without delay.
<b>Restriction on Working Hours</b>	<b>45.1</b>	Add the following under Sub-clause 45.1:  Drilling and dismantling work will be carried out exclusively after office working hours and/or on holidays only. Execution of work to be carried out by ensuring minimum disruption to the working of bank officials.
<b>Reduction of Liquidated Damages</b>	<b>47.2</b>	Delete the Sub-Clause in its entirety.
<b>Instructions for Variations</b>	<b>51.2</b>	The Sub-Clause has been amended as under:  The Contractor shall not make any such variation without an instruction of the Engineer in writing. Provided that no instruction shall be required for increase or decrease in the quantity of any work where such increase or decrease is not the result of an instruction given under this Clause, but is the result of the quantities exceeding or being less than those stated in the Bill of Quantities.
<b>Valuation of Variations</b>	<b>52.1</b>	The Sub-Clause has been amended as under:  All variations referred to in Clause 51 and any additions to the Contract Price which are required to be determined in accordance with Clause 52 (for the purposes of this Clause referred to as "varied work"), shall be valued by the Engineer on the basis of similar items covered in the Bill of Quantities, insofar as such rates or prices apply and where such rates or prices do not directly apply, the value shall be based on the rates or prices deduced there from so far as it is practicable to do so. If the same is not provided in the Bill of Quantities then the valuation will be carried out on the basis of the applicable item rates of MES Schedule of Rates 2021 or latest available with the application of premium as notified by Engineer in Chief's Branch, GHQ, Rawalpindi. If the same is not covered in latest MES Schedule of Rates then the valuation will be carried out on the basis of current market rates for labour, material etc. No escalation on account of material, labour, POL etc. shall be allowed on such items if the valuation is carried out on the basis of MES Schedule of Rates 2021 or latest available with the application of premium as notified by Engineer in Chief's Branch, GHQ, Rawalpindi and on the basis of current market rates. For valuation of current market rates the percentage of overheads, all applicable taxes, duties, levies & profit, etc. to be added in such cases for Civil and Plumbing Works excluding Pumps shall be twenty



five percent (25%) and fifteen percent (15%) for Electrical, HVAC, Lifts and Pumps.

In the event of disagreement, the Engineer shall within a period not exceeding one-eighth of the completion time subject to a minimum of 56 days from the date of disagreement whichever is later fix such rates or prices as are, in his opinion, appropriate and shall notify the Contractor accordingly, with a copy to the Employer. Until such time as rates or prices are agreed or fixed, the Engineer shall determine provisional rates or prices to enable on-account payments to be included in certificates issued in accordance with Clause 60.

The approval / finalization of rates of all variations shall not relieve the Contractor of his obligations under the Contract. The Contractor shall neither stop the work nor slow down the progress of the Works in awaiting the approval of rates of all variations.

**Power of  
Engineer to Fix  
Rates**

**52.2** The Sub-Clause has been amended as under:

Provided that if the nature or amount of any varied work relative to the nature or amount of the whole of the Works or to any part thereof, is such that, in the opinion of the Engineer, the rate or price contained in the Contract for any item of the Works is, by reason of such varied work, rendered inappropriate or inapplicable, then, after due consultation by the Engineer with the Employer and the Contractor, a suitable rate or price shall be agreed upon between the Engineer and the Contractor. In the event of disagreement, the Engineer shall fix such other rate or price as is, in his opinion, appropriate and shall notify the Contractor accordingly, with a copy to the Employer. Until such time as rates or prices are agreed or fixed, the Engineer shall determine provisional rates or prices to enable on-account payments to be included in certificates issued in accordance with Clause 60.

Provided also that no varied work instructed to be done by the Engineer pursuant to Clause 51 shall be valued under Sub-Clause 52.1 or under this Sub-Clause unless, within 14 days of the date of such instruction and, other than in the case of omitted work, before the commencement of the varied work, notice shall have been given with a copy to the Employer either:

- (a) by the Contractor to the Engineer of his intention to claim extra payment or a varied rate or price, or
- (b) by the Engineer to the Contractor of his intention to vary a rate or price.

**Failure to  
Comply**

**53.1** Delete this Clause in its entirety.  
**53.4**

**Conditions of  
Hire of  
Contractor's  
Equipment**

**54.5** Add the following paragraph at the end:

The Contractor shall, upon request by the Engineer at any time in relation to any item of hired Contractor's Equipment, forthwith notify the Engineer in writing the name and address of the Owner of the equipment and shall certify that the agreement for the hire thereof contains a provision in accordance with the requirements set forth above.

Add the following Sub-Clause 54.9:

**Testing of  
Contractor's  
Equipment**

**54.9 a. Definitions**

For the purpose of Sub-Clause 54.



**Temporary  
Works and  
Materials**

- i. The expression "Construction Equipment" shall be deemed to exclude vehicles engaged in transporting any labour equipment or materials to or from the site.
- ii. The expression "Essential Hired Equipment" shall mean all Constructional Equipment Temporary Works and materials of Temporary Work the withdrawal of which in the event of termination under Sub-Clause 63 hereof might (having regard to the methods of construction employed prior to the termination) endanger the safety or stability of or result in serious disturbance to the execution of any part of the Works and which are held by the Contractor under any agreement for hire thereof.
- iii. The expression "Hired Equipment" shall mean any Constructional Equipment, Temporary Works (other than essential hired equipment) held by the Contractor under any agreement for hire thereof.
- iv. The expression "Agreement for Hire" shall be deemed not to include an agreement for hire purchase with an option to purchase or for conditional sale either of which is herein referred to as an "agreement for the purchase".
- v. The expression "Hire Purchase Equipment" shall mean any Constructional Equipment, Temporary Works held by the Contractor under an agreement for hire purchase thereof.
- vi. The expression "owner" mean the owner of the equipment of any Hire Purchase Equipment.

**b. Vesting of Certain Equipment**

All Constructional Equipment, Temporary Works and material owned by the Contractor or by any company in which the Contractor has a controlling interest shall when brought on to the site (or in the case of hire purchase equipment upon becoming the property of the Contractor) shall be and shall be deemed to become the property of the Employer.

**c. Conditions of Hire of Certain Equipment**

With a view to securing in the event of termination Sub-Clause 63 hereof the continued availability for the purpose of executing the Works of any essential hired equipment the Contractor shall not bring on to the Site any essential hired equipment unless the agreement for hire thereof contains a provision that the owner will on request in writing made by the Employer within 7 days after the date on which any such termination has become effective and on the Employer undertaking to pay all hire charges in respect thereof on the same terms in all respects as the same was hired to the contractor save that the Employer shall be entitled to permit the use thereof by any other contractor employed by it for the purposes of completing the works under the terms of Sub-Clause 63 hereof.

**d. Costs for purpose of Sub-Clause 63**

In the event of the Employer entering into any agreement for hire of essential hired equipment pursuant to the provisions of Sub-Clause 54.9(c) all sums properly paid by the Employer under the provisions of any such agreement and all expenses incurred by it (including stamp duties) in entering into such agreement shall be deemed for the purpose of Sub-Clause 63 hereof to be part of the cost of completing the Works.



**e. Contractor's Certificate as to Hiring Provisions**

The Contractor shall upon request made by the Engineer at any time in relation to any item of essential hired equipment forthwith notify to the Engineer in writing the name and address of the owner and shall certify that the agreement for the hire thereof contains a provision in accordance with the requirements of Sub Sub-Clause 54.9(c) hereof. The Contractor shall also upon request as aforesaid give a like notification (but without certificate) in regard to any hire purchase equipment.

**f. Hire Purchase Payment by the Employer**

The Employer shall in order to avoid seizure by the owner of any hire purchase equipment be entitled to pay to such owner the amount of any overdue installment or other sum payable optionally or otherwise under any Agreement of hire purchase and in the event of his doing so any amount so paid by him shall be debt due from the Contractor to the Employer and may be deducted by the Employer from any moneys due or that may become due to the Contractor under the Contract or may be recovered by the Employer from the Contractor at law.

**g. Irrevocability of Certain Equipment etc.**

No Constructional Equipment Temporary Works or materials or any part thereof shall be removed from the site without the written consent of the Engineer which consent shall not be unreasonably withheld where the same is no longer immediately required for the purposes of completion of the Works but the Employer will permit the Contractor the exclusive use of all such Constructional Equipment, Temporary Works and materials in and for the completion of the Works until the occurrence of any event which gives the Employer the right to expel the Contractor from the site and proceed with the completion of the Works.

**h. Revesting and Removal of Equipment**

Upon the removal with the consent of the Engineer of any such Constructional Equipment, Temporary Works or materials as have been deemed to have become the property of the Employer under Sub-Clause 54.9(b) the property therein shall be deemed to revest in the Contractor and, upon completion of the Works the property in the remainder of such Constructional Equipment, Temporary Works and materials as aforesaid shall subject to the provisions of Sub-Clause 63 be deemed to revest in the Contractor who shall remove the same together with any essential hired equipment or hire purchase equipment. If the Contractor shall fail to remove any Constructional Equipment, Temporary Works or materials as aforesaid or any essential hire equipment or hire purchase equipment within such reasonable time after completion of the Works as may be allowed by the Engineer then the Employer may:

- i. Sell any such Constructional Equipment, Temporary Works and materials as aforesaid, and
- ii. Return at the Contractor's expenses to the person firm or company from whom any Essential Hired Equipment or any Hire Purchase Equipment was held by the Contractor such essential hire



equipment or hire purchase equipment, and after deducting from any proceeds of sale, the costs, charges and expenses of and in connection with such sale and return as aforesaid shall pay the balance (if any) to the Contractor but to the extent that the proceeds of any sale are insufficient to meet all such cost, charges and expenses the excess shall be a debt due from the Contractor to the Employer and shall be deductible or recoverable by the Employer accordingly as aforesaid.

**j. Liability for loss or injury to Equipment**

The Employer shall not at any time be liable for the loss of or injury to any of the Constructional equipment, Temporary Works or materials which have been deemed to become the property of the Employer under Sub-Clause 54.9(b) hereof save as mentioned in Sub-Clause 20 hereof.

**k. Incorporation of Sub-Clause in Sub-Contracts**

The Contractor shall when entering into any sub-contract for the execution of any part of the Works incorporate in such sub-contract (by reference or otherwise) the provisions of this Sub-Clause in relation to Constructional Equipment, Temporary Works and materials. Essential Hired Equipment and Hire Purchase Equipment to be brought on the Site by the sub-contractor.

**l. Approval of Materials etc., not implied**

The operation of sub Sub-Clause 54.9(b) hereof shall not be deemed to imply any approval by the Engineer of the materials or other matters referred to therein nor shall it prevent the rejection of any materials at any time by the Engineer.

The following Sub-Clauses 59.4 & 59.5 are added:

**Payments to  
Nominated  
Subcontractors**

**59.4** The Contractor shall pay to the nominated Subcontractor the amounts which the Engineer certifies to be due in accordance with the subcontract. These amounts plus other charges shall be included in the Contract Price in accordance with Clause 58 [Provisional Sums], except as stated in Sub-Clause 59.5 [Certification of Payments].



**Certification of  
Payments &  
Nominated  
Subcontractors**

**59.5** The sub-clause is amended as under:

Before issuing a Payment Certificate which includes an amount payable to a nominated Subcontractor, the Engineer may request the Contractor to supply reasonable evidence that the nominated Subcontractor has received all amounts due in accordance with previous Payment Certificates, less applicable deductions for retention or otherwise. Unless the Contractor:

- a. submits reasonable evidence to the Engineer, or
- b. i) satisfies the Engineer in writing that the Contractor is reasonably entitled to withhold or refuse to pay these amounts,  
ii) submits to the Engineer reasonable evidence that the nominated Subcontractor has been notified of the Contractor's entitlement,

then the Employer may (at his sole discretion) pay direct to the nominated Subcontractor, part or all of such amounts previously certified (less applicable deductions) as are due to the nominated Subcontractor and for which the Contractor has failed to submit the evidence described in sub-paragraphs (a) or (b) above. The Contractor shall then repay, to the Employer, the amount which the nominated Subcontractor was directly paid by the Employer.

**Monthly  
Statements**

**60.1** The Sub-Clause is amended as under:

- a. The Contractor shall on the basis of the joint measurement of work done under Clause 56.1 submit to the Engineer after the end of each month two copies, each signed by the Contractor's representative approved by the Engineer in accordance with the Sub-Clause 15.1, of a statement, in such form as the Engineer may from time to time prescribe, showing the amounts to which the Contractor considers himself to be entitled up to the end of the month in respect of:
  - i. the value of the Permanent Works executed,
  - ii. any other items in the Bill of Quantities including those for Contractor's Equipment, Temporary Works, day works and the like,
  - iii. the percentage of the invoice value of listed materials, all as stated in the Appendix to Tender, and Plant delivered by the Contractor on the Site for incorporation in the Permanent Works but not incorporated in such Works,
  - iv. adjustments under Clause 70, and
  - v. any other sum to which the Contractor may be entitled under the Contract or otherwise.

**b.** Payments shall be made at the following stages:

- I. Upon delivery of FCU, payment for supply of equipment to contractor (**BOQ Section D, HVAC item No. 43 and 44**) shall not exceed 70% of the approved BOQ amount. This payment shall be made after successful delivery of equipment at site and after deduction of Mobilization Advance (if availed) and inspection of goods by the Engineer at site.
- II. Rest of the amount for Section D- HVAC Item 43 and 44 (including rest 30% of supply part & installation charges) of all work done as approved BOQ amount will only be made after successful testing and commissioning of all equipment and devices mentioned in BOQ after issuance of Completion Certificate. Payment of all other items of HVAC section shall be made as per work done



III. Payment against Civil / Architectural/ Electrical / Firefighting / Sight Screen works will be made as per work done.

**c. Payment against rationalized BOQ**

“If the rate of any item of the successful bidder is abnormally high i.e. 15% more or higher than the rate of the same items in Engineer’s Estimate, the Employer may require the bidder to produce detailed price analyses for any or all such items of Bid of the successful Bidder to demonstrate the internal consistency of those prices. After evaluation of the price analyses by the Employer / Engineer the rate of successful bidder (if required) will be rationalized in following manner and the decision of the Employer / Engineer in this regard shall be final and binding on the successful bidder:

- i. The rate or price of individual abnormally high quoted items compared with the Engineer’s Estimate would be decreased to the individual item rate of the Engineer’s Estimate. The revised BOQ so prepared will be called as Rationalized BOQ duly stamped and signed by the successful bidder which shall be final and binding for interim payment purposes only. Withheld amount(s) of abnormally high quoted items shall be released during finishes stage or at such stage when items identified as below / lower to Engineer’s estimate are in progress resulting in making final payments as per original quotes.

**Monthly  
Payments**

**60.2** The Sub-Clause is amended as under:

The Engineer shall, within 14 days of receiving such statement, certify and deliver to the Employer an Interim Payment Certificate stating the amount of payment to the Contractor which the Engineer considers due and payable in respect of such statement, subject:

- (a) firstly, to the retention of the amount calculated by applying the Percentage of Retention stated in the Appendix to Tender, to the amount to which the Contractor is entitled under paragraph a. (i, ii, iii and v), b. of Sub-Clause 60.1 until the amount so retained reaches the Limit of Retention Money stated in the Appendix to Tender,
- (b) secondly, to the deduction, other than pursuant to Clause 47, of any sums which may have become due and payable by the Contractor to the Employer,
- (c) Thirdly to the deduction of Advance Income Tax and other applicable taxes in accordance with the applicable laws, and
- (d) The Employer may suspend payment of the Interim Payment Certificate in case it is directed by to do so, by Pakistan Customs, FIA and other competent government agencies till the matter is officially cleared by the Government.

Provided that the Engineer shall not be bound to certify any payment under this Sub-Clause if the net amount thereof, after all retentions and deductions, would be less than the Minimum Amount of Interim Payment Certificates stated in the Appendix to Tender.

Notwithstanding the terms of this Clause or any other Clause of the Contract no amount will be certified by the Engineer for payment until the performance security, if required under the Contract, has been provided by the Contractor and approved by the Employer.





- Time for Payment**    **60.10**    The Sub-Clause is amended as under:
- The amount due to the Contractor under any Interim Payment Certificate issued by the Engineer pursuant to this Clause, or to any other terms of the Contract, shall, subject to Clause 47, be paid by the Employer to the Contractor within 28 days after such Interim Payment Certificate has been delivered to the Employer, or, in the case of the Final Certificate referred to in Sub Clause 60.8, within 56 days after such Final Payment Certificate has been delivered to the Employer. In the event of failure of the Employer to make payment within the times stated due to circumstances beyond his control, the Employer shall not pay to the Contractor any interest or compensation of any sort.

Add the following Sub-Clauses 60.11 to 60.13:

- Financial Assistance to Contractor**    **60.11**    Financial assistance shall be made available to the Contractor by the Employer as follows:
- a. An interest-free Mobilization Advance up to fifteen percent (15%) of the Contract Price stated in the Letter of Acceptance (excluding the cost of Operation and Maintenance) shall be paid by the Employer to the Contractor in two equal parts upon submission by the Contractor of a Mobilization Advance Guarantee for the full amount of the Advance in the specified form, from Scheduled Bank(s) in Pakistan:
    1. First part within twenty-eight (28) days after signing of the Agreement or date of receipt of Engineer's Notice to Commence, whichever is earlier; and
    2. Second part within forty-two (42) days from the date of payment of the first part, subject to the satisfaction of the Engineer as to the state of the following:
      - i. shaving completed at least 2% of the permanent works (to be assessed by the Engineer)
  - b. This Advance shall be recovered @ 20% of the amount of work done from Interim Payment Certificates (IPC) and shall be fully recovered at least two months before scheduled completion time. The validity of Mobilization Advance Guarantee shall be valid for the Contract Period. Such Guarantee may be progressively reduced to the balance amount of Mobilization Advance indicated in Interim Payment Certificates of the Engineer issued in accordance with this Clause after receipt and verification of the revised guarantee not less than the due amount of mobilization advance.
- Withholding of Payment**    **60.13**    a. The Employer at his own or on the recommendations of the Engineer may withhold the whole or part of any payment requested by the Contractor if it is necessary in his opinion to protect himself against losses on account of the following reasons:
- i. Defective work not rectified.
  - ii. Non-fulfillment of any due demand and guarantee or renewal of any guarantee or surety.
  - iii. Claims if third parties raised against the Employer caused through the fault of the Contractor in connection with the works.
  - iv. Damage caused by the Contractor or his personnel or any sub contractor, to the Employer, or to a third party on the site.
  - v. Non-fulfilment of the Contract by the Contractor.
  - vi. Non-fulfilment of the Contractual Obligation towards submittal of Shop Drawings, Bar Bending Schedules, Samples, Mock-Up samples, As-built drawings, etc.



- b. After the reasons of withholding of payments have been eliminated to the satisfaction of the Employer and the Engineer, payments to the Contractor will be undertaken by the Employer without delay.

**Default of Contractor**

**63.1** Delete the Sub-Clause and replace with following:

**(a)** If the Contractor abandons the Works, delays abnormally, or misses the target dates mentioned in the approved Work Program or refuses or fails to comply with a valid instruction of the Employer, or if Contractor materially or consistently breaches the Contract, the Employer may give a notice under this sub-clause stating the default. If the Contractor has not taken practicable steps to remedy the default or cover up the backlog within fifteen (15) days after receipt of the Employer's notice, the Employer may by serving a second notice within twenty five (25) days, terminate the Contract asking the Contractor to demobilize from the Site leaving behind the Equipment required for completion of the outstanding Works at risk & cost of the Contractor or the Employer may deploy extra resources to cover up the backlog at the risk & cost of the Contractor. The decision of the Director/Head Engineering will be final and conclusive in this regard.

**(b) Employer's sole discretion:**

The Employer shall be entitled to terminate the Contract, at any time for the Employer's convenience, by giving notice of such termination to the Contractor. The termination shall take effect within 15 days after the Contractor receives the notice.

**(c) Insolvency:**

If either part is declared (or is likely to be declared) insolvent under any applicable law, the other party may terminate the Contract by serving a notice immediately. The Contractor shall demobilize from the Site leaving behind the Equipment required for completion of the outstanding Works in case of Contractor's insolvency.

**(e) Criminal/ Offensive act by the Contractor or his employees:**

If the Contractor or any of his employees commits a serious crime within the premises of the Employer which can result in police action under Penal Code Act of Pakistan, the Employer may terminate the Contract by serving a notice to the Contractor and the Contractor shall demobilize from the Site leaving behind the Equipment required for completion of the outstanding Works at the risk & cost of the Contractor.

**(f) Actions in case of failure of the Contractor:**

If the Contractor fails to complete the Works even when the amount of Liquidated Damages has reached to the maximum fixed limit or the Contractor abandons or suspends the Works, or commits breach of the terms & conditions of the Contract, the Contractor or any of his employees commits a serious crime within the premises of the Employer which can result in police action under Penal Code Act of Pakistan or in any case in which the contractor shall have rendered himself liable to pay compensation/liquidated damages, the Director/Head Engineering whose decision shall be final & conclusive, without prejudice to any other right or remedies, shall have power to adopt all or any of the following courses as he may deem best suited to the interest of the Employer;

- i. To rescind the Contract (of which the rescission notice in \_\_\_\_\_ Contractor under the hand of Director/Head Engineering shall be \_\_\_\_\_)

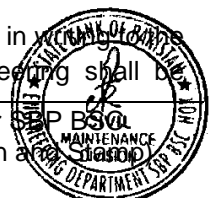

conclusive evidence) and in which case the retention money and Performance Security of the Contractor shall be forfeited and be absolutely at the disposal of the Bank;

- ii. To employ labour paid by the Employer and to supply materials to carry out the Works or any part of the Works, debiting the Contractor with the cost of all labour and the price of the materials (of the amount of which cost and price a certificate of the Director/Head Engineering shall be final & conclusive against the Contractor) and crediting him with the value of the work done in all respects in the same manner and at the same rates as if it had been carried out by the Contractor under the terms of this Contract; the certificate of the Director/Head Engineering as to the value of the work done shall be final and conclusive against the Contractor;
- iii. To measure up the works of the Contractor and to take such part thereof as shall be un-executed out of his hands and give it to another contractor to complete, in which case any expenses which may be incurred in excess of the sum which would have been paid to the original Contractor, if the whole had been executed by him (of the amount of which excess the certificate in writing of the Director/Head Engineering shall be final and conclusive) shall be borne and paid by the original Contractor and may be deducted from any money due to him by the Bank under the Contract or otherwise, or from his retention money or the proceeds of sale thereof or sufficient part thereof;
- iv. If any of the above courses being adopted by the Director/Head Engineering, the Contractor shall have no claim to compensation for any loss sustained by him by reasons or his having purchased or procured any materials, or entered in to any engagements or made any advances on account of, or with a view to the execution of the works or the performance of the Contract. And in case the Contract shall be rescinded under the provisions aforesaid, the Contractor shall not be entitled to recover or be paid any sum for any works theretofore actually performed under this Contract unless and until the Director/Head Engineering will have certified in writing the performance of such works and the value payable in respect thereof and he shall be only be entitled to be paid the value so certified.
- v. In case of Contractor's failure to perform in line with the agreed terms & conditions laid down in the contract, the Employer may blacklist the Contractor for future opportunities at the Employer as per clause 18.2 and decision of the Director/Head Engineering will be final & conclusive. As per Public Procurement Rule-19, the Contractor will be accorded adequate opportunity of being heard.

Notwithstanding to above, Bank will serve notice to the Contractor for joint measurement of work executed. In case Contractor fails to attend joint measurement, ex parte measurement shall be carried out.

**Special Risks 65.2** The Sub-Clause is amended as under:

The Special Risks are the risks defined under Sub-Clause 20.4 paragraph a (i) to (v).

**Out Break of War 65.6** The Sub-Clause is amended as under:



If, during the currency of the Contract, there is an outbreak of war, whether war is declared or not, which, whether financially or otherwise, materially affects the execution of the Works, the Contractor shall, unless and until the Contract is terminated under the provisions of this Clause, continue to use his best endeavour to complete the execution of the Works. Provided that the Employer shall be entitled, at any time after such outbreak of war, to terminate the Contract by giving notice to the Contractor and, upon such notice being given, the Contract shall, except as to the rights of the parties under this clause and Clause 67, terminate, but without prejudice to the rights of either party in respect of any antecedent breach thereof.

**Arbitration 67.3** The Sub-Clause is amended as under:

Any dispute in respect of which:

(a) the decision, if any, of the Engineer has not become final and binding pursuant to Sub-Clause 67.1, and

(b) amicable settlement has not been reached within the period stated in Sub-Clause 67.2,

shall be finally settled, under the provisions of the Arbitration Act, 1940 as amended or any statutory modification or re-enactment thereof for the time being in force. The said arbitrator/s shall have full power to open up, review and revise any decision, opinion, instruction, determination, certificate or valuation of the Engineer related to the dispute.

Neither party shall be limited in the proceedings before such arbitrator/s to the evidence or arguments put before the Engineer for the purpose of obtaining his said decision pursuant to Sub-Clause 67.1. No such decision shall disqualify the Engineer from being called as a witness and giving evidence before the arbitrator/s on any matter whatsoever relevant to the dispute.

Arbitration may be commenced prior to or after completion of the Works, provided that the obligations of the Employer, the Engineer and the Contractor shall not be altered by reason of the arbitration being conducted during the progress of the Works.

The place of arbitration shall be **Karachi**, Pakistan.

**Notices to Contractor 68.1** The Sub-Clause is amended as under:

All certificates, notices or instructions to be given to the Contractor by the Employer or the Engineer under the terms of the Contract shall be sent by post, cable, telex or facsimile transmission to or left at the Contractor's principal place of business or such other address as the Contractor shall nominate for that purpose.

For the purposes of this Sub-Clause, the Contractor shall, immediately after receipt of Letter of Acceptance, intimate in writing to the Employer and the Engineer by registered post, the address of his principal place of business or any change in such address during the period of the Contract.

**Notice to Employer and Engineer 68.2** For the purposes of this Sub-Clause, the respective addresses are:

**a) The Employer:**

Director / Head Engineering  
1<sup>st</sup> floor SBP Bolton Market Building  
State Bank of Pakistan (SBP), Banking Services Corporation  
(BSC)



Head Office Karachi (HOK), M.A. Jinnah Road, Karachi

**b) The Engineer**

To be nominated later

**Default Of Employer** 69.1 The Sub-Clause is amended as under:

In the event of the Employer:

(a) failing to pay to the Contractor the amount due under any certificate of the Engineer within 56 days after the expiry of the time stated in Sub-Clause 60.10 within which payment is to be made, subject to any deduction that the Employer is entitled to make under the Contract,

(b) interfering with or obstructing or refusing any required approval to the issue of any such certificate,

(c) becoming bankrupt or, being a company, going into liquidation, other than for the purpose of a scheme of reconstruction or amalgamation, or

(d) giving notice to the Contractor that for economic reasons it is impossible for him to continue to meet his contractual obligations,

the Contractor shall be entitled to terminate his employment under the Contract by giving notice to the Employer, with a copy to the Engineer. Such termination shall take effect 14 days after the giving of the notice.

**Contractor's Entitlement to Suspend Work**

69.4 The Sub-Clause is amended as under:

Without prejudice to the Contractor's entitlement to interest under Sub-Clause 60.10 and to terminate under Sub-Clause 69.1, the Contractor may, if the Employer fails to pay the Contractor the amount due under any certificate of the Engineer within 56 days after the expiry of the time stated in Sub-Clause 60.10 within which payment is to be made, subject to any deduction that the Employer is entitled to make under the Contract, after giving 56 days' prior notice to the Employer, with a copy to the Engineer, suspend work or reduce the rate of work.

If the Contractor suspends work or reduces the rate of work in accordance with the provisions of this Sub-Clause and thereby suffers delay or incurs costs the Engineer shall, after due consultation with the Employer and the Contractor, determine:

(a) any extension of time to which the Contractor is entitled under Clause 44, and

(b) the amount of such costs, which shall be added to the Contract Price,

and shall notify the Contractor accordingly, with a copy to the Employer.

**Increase or Decrease of Cost**

70.1 Delete Sub-Clause 70.1 in its entirety, and substitute with the following:

70.1.1 The amounts payable to the Contractor, pursuant to Sub-Clause 60.1, shall be adjusted in respect of the rise or fall in the cost of labor, materials, and other inputs to the Works, by applying to such amount the formula prescribed in this Sub-Clause. Price Adjustment under this Sub-Clause shall not be applicable on supply parts of the items listed in Sub-Clause 70.1.2 (a) and Operation & Maintenance Services.

**(a) Other Changes in Cost**



To the extent that full compensation for any rise or fall in costs to the Contractor is not covered by the provisions of this or other Clauses in the Contract, the unit rates and prices included in the Contract shall be deemed to include amounts to cover the contingency of such other rise or fall of costs.

**(b) Adjustment Formula**

The adjustment to the monthly statements in respect of changes in cost shall be determined from the following formula:-

$$P_n = A + b \frac{L_n}{L_o} + c \frac{C_n}{C_o} + d \frac{S_n}{S_o}$$

$P_n$  is a price adjustment factor to be applied to the amount for the payment of the work carried out in the subject month, determined in accordance with Paragraph 60.1 a. i., ii. And v., where any variations and daywork are not otherwise subject to adjustment;

A is a constant, specified in the Appendix-C to Bid, representing the nonadjustable portion in contractual payments;

b, c, d are weightages or coefficients representing the estimated proportion of each cost element (Labour, G.S. Sheet and High Speed Diesel) in the Works or Sections thereof, net of Provisional Sums and Prime Cost; the sum of A, b, c, d, e shall be one;

$L_n$ ,  $C_n$ ,  $S_n$  and  $D_n$  are the current cost indices or reference prices of the cost elements for month "n", determined pursuant to Sub-Clause 70.1(d), applicable to each cost element; and:

**(c) Sources of Indices and Weightages**

The sources of indices shall be those listed in the Appendix-C to Bid.

**(d) Base, Current, and Provisional Indices**

The base cost indices or prices shall be those prevailing on the day 28 days prior to the latest date for submission of bids. Current indices or prices shall be those prevailing on the day 28 days prior to the start of the execution month to which a particular monthly statement is related. If at any time the current indices are not available, provisional indices as determined by the Engineer will be used, subject to subsequent correction of the amounts paid to the Contractor when the current indices become available.

**(e) Adjustment after Completion**

If the Contractor fails to complete the Works within the Time for Completion prescribed under Clause 43, adjustment of prices thereafter until the date of completion of the Works shall be made using either the indices or prices relating to the prescribed time for completion, or the current indices or prices, whichever is more favorable to the Employer, provided that if an extension of time is granted pursuant to Clause 44, the above provision shall apply only to adjustments made after the expiry of such extension of time.

**(f) Weightages**

The weightages for each of the factors of cost given in Appendix-C to Bid shall be adjusted if, in the opinion of the



Engineer, they have been rendered unreasonable, unbalanced, or inapplicable as a result of varied or additional work executed or instructed under Clause 51. Such adjustment(s) shall have to be agreed in the variation order.

Add the following Sub-Clauses 73.1, 73.2, 74.1, 75.1, 76.1, 77.1, 78.1, 79.1, 80.1, 80.2, 80.3, 80.4, 80.5, 80.6, 80.7, 80.8, 81.1 to 81.7:

- |   |             |   |
|---|-------------|---|
| <b>Payment of Income Tax</b>                              | <b>73.1</b> | The Contractor, Subcontractors and their employees shall be responsible for payment of all their income tax, super tax and other taxes on income arising out of the Contract and the rates and prices stated in the Contract shall be deemed to cover all such taxes.   |
| <b>Cost inclusive of duties and taxes</b>                 | <b>73.2</b> | The rates and prices stated in the priced Bill of Quantities shall be deemed to include every element of duty or tax leviable on or in relation to the production, import, purchase, sale, delivery and transportation of materials and to the bringing thereof to the Site and no such duty or tax shall be separately reimbursable.   |
| <b>Integrity Pact</b>                                     | <b>74.1</b> | <p>If the Contractor or any of his Subcontractors, agents or servants is found to have violated or involved in violation of the Integrity Pact signed by the Contractor as Appendix-L to his Bid, then the Employer shall be entitled to:</p> <p>(a) recover from the Contractor an amount equivalent to ten times the sum of any commission, gratification, bribe, finder's fee or kickback given by the Contractor or any of his Subcontractors, agents or servants;</p> <p>(b) terminate the Contract; and</p> <p>(c) recover from the Contractor any loss or damage to the Employer as a result of such termination or of any other corrupt business practices of the Contractor or any of his Subcontractors, agents or servants.</p> <p>The termination under Sub-Para (b) of this Sub-Clause shall proceed in the manner prescribed under Sub-Clauses 63.1 to 63.4 and the payment under Sub-Clause 63.3 shall be made after having deducted the amounts due to the Employer under Sub-Para (a) and (c) of this Sub-Clause</p> |
| <b>Termination of Contract for Employer's Convenience</b> | <b>75.1</b> | <p>The Employer shall be entitled to terminate the Contract at any time for the Employer's convenience after giving 56 days prior notice to the Contractor, with a copy to the Engineer. In the event of such termination, the Contractor:</p> <p>a. shall proceed as provided in Sub-Clause 65.7 hereof; and</p> <p>b. shall be paid by the Employer as provided in Sub-Clause 65.8 hereof.</p>  |
| <b>Liability of Contractor</b>                            | <b>76.1</b> | The Contractor or his Subcontractors or assigns shall follow strictly, all relevant labour laws including the Workmen's Compensation Act and the Employer shall be fully indemnified for all claims, damages etc. arising out of any dispute between the Contractor, his Subcontractors or assigns and the labour employed by them.   |
| <b>Joint and Several Liability</b>                        | <b>77.1</b> | If the Contractor is a joint venture of two or more persons, all such persons shall be jointly and severally bound to the Employer for the fulfillment of the terms of the Contract and shall designate one of such persons to act as leader with authority to bind the joint venture. The composition or the constitution of the joint venture shall not be altered without the prior consent of the Employer.   |



- Details to be Confidential**    **78.1**    The Contractor shall treat the details of the Contract as private and confidential, save in so far as may be necessary for the purposes thereof, and shall not publish or disclose the same or any particulars thereof in any trade or technical paper or elsewhere without the prior consent in writing of the Employer or the Engineer. If any dispute arises as to the necessity of any publication or disclosure for the purpose of the Contract, the same shall be referred to the decision of the Engineer whose award shall be final.
- Precaution for Pollution**    **79.1**    Precautionary measures and facilities shall be provided by the Contractor at his own cost in carrying out the Works including dumping and disposal of spoils, in the manner approved by the Engineer to prevent environmental pollution.
- Black Listing Mechanism**    **80.1**    Code of Conduct:
- b) It is the Employer's policy that the Contractors observes the highest standards of ethics during the procurement and execution of such contracts. In pursuit of this policy, the Employer follows, inter alia, the instructions contained in PPR-2004 which defines:
    - (i) “coercive practices” which means any impairing or harming or threatening to impair or harm, directly or indirectly, any party or the property of the party to influence the actions of a party to achieve a wrongful gain or to cause a wrongful loss to another party;
    - (ii) “collusive practices” which means any arrangement between two or more parties to the procurement process designed to stifle open competition for any wrongful gain, and to establish prices at artificial, non-competitive levels;
    - (iii) “corrupt practices” which means the offering, giving, receiving or soliciting, directly or indirectly, of anything of value to influence the acts of another party for wrongful gain;
    - (iv) “fraudulent practices” which means any act or omission, including a misrepresentation, that knowingly or recklessly misleads, or attempts to mislead, a party to obtain a financial or other benefit or to avoid an obligation; and
    - (v) “obstructive practices” which means harming or threatening to harm, directly or indirectly, persons to influence their participation in a procurement process, or affect the execution of a contract.
  - c) Under Rule-19 of PPR-2004, the Employer can inter alia blacklist and debar the Contractor found to be indulging in practices mentioned at para a) above. Such matters would be referred to the Blacklisting Committee of the Employer that is empowered to take actions accordingly. Such blacklisting or barring action shall be communicated by the Employer to PPRA and the Contractor in the form of decision containing the grounds for such action.

Nature of Fault	Means of Verification
Corruption	Actual instance verifiable as per law of land and applicable rules and regulations of SBP
Deviation from commitment	If the bidder deviates from its prior commitment or declaration made regarding the bid or proposal submitted by the bidder.





<b>Fraud</b>	Cross verification of documentary undertakings submitted by Bidder
<b>Collusion</b>	Results of Bid analysis resulting in substantive evidence of collusion

**Warranty 80.2** The Contractor shall provide the Manufacturer's Warranty for Equipment if Supplied under the Contract, which shall cover all imported items against materials, fabrication, workmanship and all other associated deficiencies for a period of 30 months of Shipment. The Contractor shall also warranty the entire installation for a period up to the expiry of Defects Liability Period inclusive of the manufacturer's Terms of Warranty for free replacement of any component, accessories or parts having become defective during the said period.

The Warranty would be in the form given below or as approved, duly executed for all items and shall form an essential part of the Shipping Documents:

"We hereby guarantee that the equipment and machinery, materials, tools and parts supplied by us are produced new in accordance with approved drawings and Contract Specifications and that the materials used whether or not of our manufacture are in accordance with the appropriate Standards (latest editions) and as specified in Contract, and we shall replace free of cost all defective equipment, machinery, materials, tools, and parts thereof which shall be found defective and not in accordance with the Contract, provided however, that a period not exceeding 30 months from the date of shipment from our factory of the parts covered by this guarantee/warranty has not elapsed. We shall also replace free of cost every part thereof in use for a period up to the expiry of Defects Liability Period, which would be found defective due to material or faulty workmanship or in any way not in accordance with the Contract Specifications / Documents."

**Fire Protection and loss control 80.3** The Contractor shall be aware of necessary precautions & controls concerning cutting, welding, and hot work, fire precautions and ensure compliance.

The Contractor shall be responsible for the fire watch as necessary and meet the fire prevention / fighting practices.

The Contractor shall, in his work plan, forecast any extra hazardous area or adjacent to the site of the work and provide curtains, shields, or any other specialized equipment to adequately shield flames and sparks from combustibles.

Where the Contractor requires the utilization of flammable liquids, approved devices and containers for transfer or storage of the same shall be used.

The Contractor is responsible for disposal of deleterious substances such as lubrication oil, solvents, diesel fuel etc. which shall be contained in suitable containers and be disposed of away from the site and in no case disposed in sewers or water course(s) or drains.

The Contractor shall provide and maintain adequate fire protection in the form of barrels of water with buckets, fire bucket tanks, fire extinguisher, or other effective means ready for instant use, distributed around the project and in and about temporary inflammable structures during construction of the works.

Gasoline and other flammable liquids shall be stored in and dispensed from safety containers approved by the Engineer and storage shall not be within building.



**Safety regulations****80.4 1) General;**

Torch-cutting and welding operations performed by the Contractor shall have the approval of the Engineer before such work is started and a chemical extinguisher is to be available at the location where such work is in progress.

The Contractor shall follow the instructions and specifications of the Civil Defense Department or any other local department concerned with such activities.

It is the Contractors responsibility to assure that the safety regulations, are followed at all times and that all his employees at site have a thorough knowledge and understanding of the safety regulations and are complying with all the safety requirements.

The Contractor must comply with all applicable accident prevention regulations and other safety work practices governed under any law of any local or provincial authority of Pakistan.

The Contractor shall comply and enforce compliance by all his sub-contractors with the highest standards of safety and accident prevention in accordance with international standards and in compliance with all applicable laws, ordinances and statutory provisions.

The Employer requires that all the Contractors' workers wear hard hats, safety shoes, and where necessary gloves, and shirts at all times while on site.

All requisite barriers, fences, warning signs, lights and other safety precautions as required for the protection of persons and property on or adjacent to the site shall be provided at the Contractor's cost.

All false work, scaffolding and handrails shall be well constructed and secured at all times. Where overhead work is being carried out, warning signs shall be installed at ground level clearly warning of the overhead work.

All warning signs shall be in two languages, English and Urdu, and shall at all times be maintained in a clean and legible condition, to the satisfaction of the Engineer.

Trash shall be removed at frequent intervals to the satisfaction of the Engineer.

Netting shall be provided at all levels where work is in progress, all around the building.

**2) Fire Protection Equipment**

The Contractor is responsible to provide the required number of fire extinguishers as well as the necessary hose line for his area of work. The type and size of fire-fighting equipment have to be approved by the Engineer.

- i. Welding / burning requires permission from the Engineer
- ii. Closing, sealed or locked walls of any fire system requires an impairment lock out notification from the Engineer.

**3) Hazardous Area**

Before entering any area, the Contractor must familiarize himself of the existing hazards and inquire from the Engineer necessary precautions to be taken for the protection of himself, other workers and equipment.



**4) Waste Material Removal and environmental control**

If the work requires the removal of any material hazardous to industrial or public / environment, then the Contractor shall remove it in compliance with industrial health and safety regulations.

**Labour Conditions**

**80.5** The Contractor acknowledges that some or all other Contractors or sub-contractors or suppliers or persons working at or delivering to or for the site or the work being carried out at or near the site may be union or non-union, Labour peace shall be maintained at the site. The Contractor shall carry out the work in a manner which ensures that there are no labour problems, work stoppages, or other labour disputes or disruptions which might affect the Contractors work, any other work at the Site or the Employers operations. The Contractor warrants and confirms that no agreement with its employees or trade unions representing his Employees or between his subcontractors. Suppliers sub-contractors and their employees or labour union representing those Employees will affect the Contractor's performance under the Contract, any other work at the site or the Employers operations. The Contractor acknowledges that the site is considered an open site, not exclusively union or non-union.

**Interim Approvals**

**80.6** The Contractor shall be responsible to get clearance / approvals of agencies for all interim inspections at different stages of the Construction. The government fees / charges will be paid by the Employer as per actual upon submission of requisite documents.

**Approval of Building Completion Plans**

**80.7** The Contractor shall prepare and submit requisite number of sets and obtain approval of Completion Plans (if any) from the respective building control authority and get approvals from utilities companies/agencies of the installations. Second part of the Retention Money shall be released after such approvals.

**The Contractor Shall Be Liable & Indemnify The Employer**

**81.1** Contractor shall be exclusively liable for and shall indemnify and hold harmless the Employer, its agents and employees from:

- i. Making good all losses arising out of the Contractor's negligence or breach of the Contract. This may include damage to the paints/polish works, false ceilings, wooden or metallic works, tiles, marbles, plants, wires, pipes, electrical and mechanical items, fixtures of any kind, antiques, glass items, window blinds, etc. The Employer shall determine the amounts of such losses/ damages and the Contractor hereby expressly waives his all or any right to change or challenge the same. The Contractor shall have to make good all such losses/ damages within time frame specified in the Notice, to the entire satisfaction of the Employer.
- ii. Any tax, government duties, insurance contributions and other taxes or social security contributions in respect of Contractor's employee(s) or sub- Contractor together in each case with any interest, fines or penalties thereon.
- iii. Any claims of Contractor / service providers current employees or ex-employees, or associates, or their heirs whether against the Contractor, other Contractors working within the same premises or any other person, regarding deals made at personal level by the staff or personal matters or deals carried out as an Employer, in whatsoever form, manner or capacity.
- iv. Any Government Permits, Licenses, etc. that may be required for performing the services contemplated under the Contract.



- i. All claims of compensation by an employee of Contractor / Service Provider, his family or legal heirs or any other agency, autonomous body, any NGO or government department, arising from injury, disability, ill health or death of any of his employees during the currency or expiry of this Contract while performing any services under this Contract or any claim regarding the medical care or treatment expenses submitted by the employee or ex-employee of the Contractor / Service Provider or their legal heirs.
- vi. Save for the willful or deliberate breach of its obligations under the Contract or, as set out above, neither party shall be liable for any consequential or indirect loss or damage.

**Contractor's Warranties**

**81.2**

The Contractor undertakes and represents that at all times:

- i. It has the requisite power and authority to enter into and perform this Agreement;
- ii. It holds valid license and authority to carry out the Services;
- iii. It shall execute the services in professional manner through competent, skilled, qualified human resource.
- iv. Contractor shall not act in a way which is prejudicial to Employer's interests or business;
- v. The Services shall be fit for the express or implied purposes for which supplied.
- vi. The Contractor shall follow the instructions to be issued by the Employer when at Employer's premises, all rules and security policies and the Employer may exclude any person from its premises for any actual or anticipated breach of these policies.

Any breach by Contractor of this Clause, constitutes a material breach of the Contract and may lead towards Termination of Contract. In addition to Employer's rights under the Contract, the Employer shall be entitled to require Contractor to (a) remedy the breach at its cost; (b) pay for it to be remedied; or / and (c) repay all amounts already paid for the defective Services.

**Contractor's Risks**

**81.3**

- i. From the Commencement Date of Operation and Maintenance until the expiry, the risks of personal injury, death, and loss of or damage to property of the Employer due to the negligence of the Contractor, his employees, associates, sub-service provider, assigns etc. (including, without limitation, the tiles, cables, wood works, paint/polish, flower pots, plants, fixtures, metallic items etc.), all such risks are Contractor's risks. Contractor shall have to make good all damages/losses to the Employer.
- ii. The Contractor shall indemnify and keep indemnified the Employer, at all times against any loss, claim, damage, charge occurred to Employer due to negligence or fraud committed by Contractor or his employee. The Contractor may obtain "Contractual Liability Insurance" to cover all claims related to Negligence / Fraud if any, committed by the Contractor. It is further clarified that the Contractor may acquire the required coverage and to contribute in fulfilling the requirements of the insurance agency. However, the

Contractor shall be responsible to indemnify the Employer within 15 days after receiving all the required supporting documents to support the claim regardless of the payment of the insurance amount paid by the insurance company to the Contractor. Failure of the Contractor to pay the Employer's claim within the afore-said period shall authorize the Employer to deduct the claimed amount from the amount of monthly Service Charges or any other amount payable to the Service Provider or encashment of Performance Security.

**Confidentiality 81.4**

Except with the consent in writing of the Employer, Contractor shall keep strictly confidential and not make use of any confidential information - supplied by the Employer other than to perform this Contract, and shall impose the same obligations on its employees and other third parties (including sub-service provider). Contractor may disclose confidential information if required to do so by law, court order, rules or regulation provided (to the extent permissible by law) it has notified the Employer in advance and agreed the scope of disclosure with the Employer.

**Independent Status of Service Provider**

**1.5**

- i. The parties agree that this contract creates an independent Contractor relationship, not an employment relationship. The Contractor acknowledges and agrees that the Employer will not provide the Contractor or its employees any fringe benefits or for the reimbursement of any expenses, including without limitation any medical or pension payments, and that all taxes are Contractor's responsibility.
- ii. The Contractor shall be exclusively responsible for paying the salary and other emoluments and providing the benefits to which each of the Contractor's employee(s) is entitled under his/her contract with the Contractor. All claims made by the Contractor's employee (s) shall be dealt with exclusively by the Contractor. None of the Contractor's employee (s) shall be entitled to seek employment with the Employer merely on the ground that he/she had been engaged by the Contractor during the tenure of this Contract or was engaged by the Contractor for the provision of the services to the Employer or was deployed to the Employer.

**Electric Power Supply, Water supply, Telephone etc. s**

**81.6**

Water for construction purposes will be provided by the Employer. Electricity will be provided by the Employer for all minor equipment & tools. Expense regarding the required cables/wires and sub-meters, switches etc. shall have to be borne by the Contractor. The Contractor shall make his own arrangement at his own expenses for the telephone & fax etc. at the Site of Works. If these facilities are to be provided by the Employer at the request of the Contractor, the Contractor shall have to pay the bills/expenses as per mutually agreed terms & conditions at that time. Hutting/ tenting etc. for the workers or storage of the materials of the contractor shall be the responsibility of the contractor.

Contract or was engaged by the Contractor for the provision of the services to the Employer or was deployed to the Employer.



Blank Page





STATE BANK OF PAKISTAN  
SBP BANKING SERVICES CORPORATION

---

**RENOVATION WORK OF LRC AUDITORIUM AT STATE BANK OF  
PAKISTAN HEAD OFFICE KARACHI**

---

**BIDDING AND CONTRACT DOCUMENTS**

**VOLUME-II**

**February 24**



## BILL OF QUANTITIES

### Preamble

1. The Bill of Quantities shall be read in conjunction with the Conditions of Contract, Specifications and Drawings.
2. The quantities given in the Bill of Quantities are estimated and provisional, and are given to provide a common basis for bidding. The basis of payment will be the actual quantities of work executed and measured by the Contractor and verified by the Engineer and valued at the rates and prices entered in the priced Bill of Quantities, where applicable, and otherwise at such rates and prices as the Engineer may fix as per the Contract.
3. A rate or price shall be entered against each item in the priced Bill of Quantities, whether quantities are stated or not. The cost of items against which the Contractor will have failed to enter a rate or price shall be deemed to be covered by other rates and prices entered in the Bill of Quantities.
4. The whole cost of complying with the provisions of the Contract shall be included in the items provided in the priced Bill of Quantities, and where no items are provided, the cost shall be deemed to be distributed among the rates and prices entered for the related items of the Works.
5. General directions and description of work and materials are not necessarily repeated nor summarized in the Bill of Quantities. References to the relevant sections of the Bidding Documents shall be made before entering prices against each item in the priced Bill of Quantities.
6. Provisional sums included and so designated in the Bill of Quantities shall be expended in whole or in part at the direction and discretion of the Engineer.
7. The Bidder before supply of Equipment / Machinery will submit the technical submittal of the equipment in accordance with already provided brochures/ technical specification and get it approved from Engineer/In-charge.
8. The brand names have been provided in order to establish a standard of performance and reliability. However, it does not indicate a preference for a particular brand. The bidder may propose other brands which can be accepted subject to necessary tests to establish equivalency.





Schedule A to Bid: Schedule of Prices

**BILL OF QUANTITIES**

S. No.	Description of Items	Quantity	Unit	Rate (Rs.)	Amount (Rs.)
<b>Section A : Dismantling, Repair &amp; Structural Works</b>					
<b>A1-Dismantling</b>					
1	Removal of existing pre-cast ceiling system including pre-cast slabs along with waterproofing membranes, screed laid underneath / insulation materials with care including stacking at the same at ground floor, removal of debris away from Bank's premises, complete in all respects as per site conditions and as directed by Engineer In-charge. (app 65ft high from GL)	4200	Sft		
2	Complete dismantling of False Ceiling including the cost of removal of all fittings/ fixtures, MS pipes, ceiling lights, unserviceable/useless electric wiring and its accessories/ conduits (PVC,GI) /fixtures/ hangers, HVAC Ducts, diffusers/ grills/ channel patti and suspension system whatever come during the execution of Job including shifting and stacking the removed materials at the designated location within the Bank premises, handing over the removed fixtures to the Bank and disposal of all debris away from the premises with disposal of all debris by using pulley arrangements so as to minimize the disturbance, etc. Complete in all respects as per site conditions and as directed by Engineer In-charge.	4200	Sft		
3	Complete dismantling of wall paneling, wooden frames, glass wool and any concealed items whatever comes during the execution of the Job including the cost of shifting and stacking the removed materials at the designated location within the Bank premises, handing over the removed items to the Bank and disposal of all debris away from the premises with disposal of all debris by using pulley arrangements so as to minimize the disturbance. Complete in all respects as per site conditions and as directed by Engineer In-charge.	3000	Sft		
4	Carefully removing existing chairs from the floor, shifting of the same at designated location within the Bank premises, making good any damage caused, etc. Complete in all respects as per site conditions and as directed by Engineer In-charge.	135	Nos.		
5	Complete dismantling of stage made of PCC flooring, with infill of charcoal underneath including the cost of handing over the removed fixtures to the Bank and disposal of all debris away from the premises with disposal of all debris by using pulley arrangements so as to minimize the disturbance, etc. Complete in all respects as per site conditions and as directed by Engineer In-charge. (Top/covered area of stage shall be taken for payment)	800	Sft		

For Bidder (Sign &amp; Stamp)

For SBP BSC (Sign &amp; Stamp)

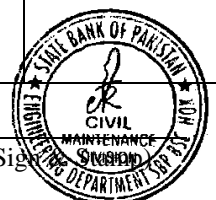

S. No.	Description of Items	Quantity	Unit	Rate (Rs.)	Amount (Rs.)
6	Dismantling of all types of existing lighting fixtures, PVC conduit pipes, all wires/cables, PA system apparatus etc. in a very safely manner and as directed by engineer-in-charge, and handing over to engineer in charge for submission in Bank's store	1	Job		
<b>A2-Repair &amp; Structural Works</b>					
7	Straightening of bent portion of bottom & top cord of all trusses and other sections damaged due to bending and making good for re-use including the cost of making slotted holes on one side of truss to convert round hole to slotted hole including the cost of Crane Machine for transporting of truss from any height to level platform for its repair with all required labors. The Contractor shall ensure covering of roof temporarily with suitable watertight canopy until the re-fixing of new roofing. Care must be taken to avoid for any kind of damage to other property of SBP, complete in all respects as per site conditions and as directed by Engineer In-charge. (The Contractor shall submit methodology of work under this Item along-with Technical Proposal of the Bid.)	1	Job		
8	Retrofitting of existing trusses as per drawings including providing, fabricating, erection, at any level, floor, height or lift, for all structural steel work conforming to ASTM A36 including welding, anchor bolts etc (Contractor should include the cost of wastages and such over laps as are not shown over drawings in rates.) including the cost of scaffolding/jacking etc. complete in all respects as per site conditions and as directed by Engineer In-charge.	2200	Kg		
9	Providing and applying of three coats of marine coating paint of Nippon or other approved equivalent brand on old & new members of all trusses, purlins and other allied MS structural components including scrapping of the surface, removal of rust and applying one coat prime coat and two coats of marine coating paint of approved shade, complete in all respect as directed by Engineer In-Charge.	1	Job		
10	Providing and fixing in position, pre-cast RCC roofing slabs having strength of 3000psi casted with 1/4" dia bars @ 6" c/c of IZHAR, Randhawa, Gondal or other approved manufacturer of required size having 2" thickness including filling of joints with 1:4 cement-sand mortar, placing etc complete in all respects as per site conditions and as directed by Engineer In-charge. Contractor to submit the technical sheet before fixing of slab.	4200	Sft		



S. No.	Description of Items	Quantity	Unit	Rate (Rs.)	Amount (Rs.)
11	Providing, mixing, laying, vibrating & curing 2" Plain Cement Concrete 1:2:4 over roof according to proper levels/slope in smooth finish, including the cost of approved quality bonding agent, providing, cutting, bending & binding of steel bars having dia. of 1/4" of Grade-40 plain steel provided @ 12" c/c in both ways, including the cost of binding wire used, trowel finish top surface, curing, etc. complete in all respects as per site requirements and as directed by the Engineer In-charge.	4200	Sft		
12	Providing and laying 4mm thick layer of APP modified bitumen & polyester met carrier based water proofing membrane slated type of Hygrip or other approved equivalent in accordance with the directions of the manufacturer/supplier including the cost of water base bitumen primer coat as specified manufacturer, including all required overlaps of minimum 4" size, etc. complete in all respects as per site requirements and as directed by the Engineer In-charge.	4200	Sft		
<b>Sub Total Section A:</b>					
<b>Section B : Architectural Works</b>					
13	Providing and applying anti-termite treatment by making about 12"-24" deep or more up to required level, 10mm dia. holes @ about 3ft c/c, using ABILITY 2.5%EC of HEXSTAR or AGENDA 2.5%EC of JAFFER Brothers or approved equivalent make, emulsion to be prepared by mixing of 1 liter of the chemical in 250 liters of water or as recommended by the manufacturer, injecting the emulsion in holes with pressure pump @ 5 liters per hole, with minimum 10 years warranty from the date of application, complete in all respects as per site requirements and as directed by the Engineer In-Charge. (Measurement for payment shall be made on basis of covered area of building floor). (The Contractor shall submit methodology of work under this Item with Technical Proposal of the Bid.)	16500	Sft		
14	Providing and applying anti-termite treatment spray/fogging of CC floor/steps/soffits of steps/walls/wooden doors/frames or any other article using Hexagen 3.5%EC of HEXSTAR or AGENDA 2.5%EC of JAFFER Brothers or approved equivalent make, emulsion to be prepared by mixing of 1 liter of the chemical in 250 liters of water or as recommended by the manufacturer, applying the emulsion by spraying min. 2 coats over the surfaces, floor, steps, walls, fogging under soffits of steps using cold foggers, injecting the emulsion in visible holes over the surface, with minimum 10 years warranty from the date of application, complete in all respects as per site requirements and as directed by the Engineer In-Charge.	1	Job		



S. No.	Description of Items	Quantity	Unit	Rate (Rs.)	Amount (Rs.)
	(The Contractor shall submit methodology of work under this Item with Technical Proposal of the Bid.)				
15	Providing & fixing of wall paneling made of non-laminated Chipboard (Patex or other approved equivalent make) of 3/4" thickness panels as per approved design, pasting of veneer sheet (Patex or other approved equivalent make) of 1/8" thickness of approved texture pressed on front side of non-laminated chipboard, fixed with partial wood framing using wood battens of size 2"x3/4" in required frame size, including the cost of providing infill of approved quality glass wool having density of 35 kg/m <sup>3</sup> with aluminum foil back filled in between wooden framing, cost of providing and fixing aluminum U-channel of size 3/4" (legs) x 1/2"(width) of Champagne color (Pak Cable, Chawla or other approved equivalent) in the grooves, including the cost of polishing, termite-proofing of entire wooden framing with approved quality anit-termite chemicals, etc. complete in all respects as per site requirements and as per the direction of Engineer In-charge.	3000	Sft		
16	Providing & fixing in position false ceiling comprising of 12mm thick gypsum board of DFB/ Douglas or other approved equivalent make, as per the design approved by the Bank, plain/ patterned/ with rafters or without rafters, pelmets, beadings/moldings/ edgings, strips, etc. including making of access panels, holes for lights & other fixtures, painting with approved colour paints including the cost of metallic suspension system, required hardware screws & adhesives, polishing/ enamel painting over rafters or other design elements, etc. complete in all respects as per site requirements and as directed by the Engineer In-Charge. Payment for payment shall be made on the basis of only length & width of the room without consideration of any overlaps, overhangs, pelmets, vertical parts etc, complete in all respects as per site requirements and as directed by the Engineer in-charge.	4200	Sft		
17	Providing & laying carpet tiles of required size and thickness of approved quality, in approved pattern as per sample available with the bank for flooring inside the auditorium, including the cost of all required adhesives, complete in all respects as per site conditions and as directed by Engineer In-charge.	3000	Sft		
18	Providing & fixing of Flexible PVC Stair Nosings app 2.5"x2.5" on stairs edges of auditorium including the cost of making requisite holes fixing with 2" screws all hardware required for execution of this Job, complete in all respects as per site requirements and as directed by Engineer-In-charge. Sample to be submitted before approval.	1200	Rft		

For Bidder (Sign &amp; Stamp)

For SBP BSC (Sign &amp; Stamp)

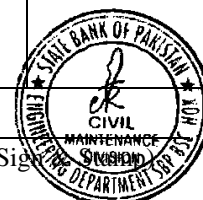

S. No.	Description of Items	Quantity	Unit	Rate (Rs.)	Amount (Rs.)
19	Providing & fixing in position wooden finish laminated flooring of Inter-wood or other approved equivalent with min. AC3 rating, with inter-locking type planks comprising of top protective layer of hardener over approved design/pattern wooden decor paper over MDF/HDF Board with melamine film pasted at back of planks, including the cost of 2mm thick approved quality foam underlay, as per the sample approved by the Bank, using adhesives of approved make including removal of existing vinyl/carpet/wooden/laminated floor, cleaning the surface, shifting and stacking of the removed flooring materials at designated place within the Bank premises, disposal of debris from the Bank premises, complete in all respects as per site requirements and as directed by the Engineer In Charge. Sample to be submitted before approval.	780	Sft		
20	Same as above but 4 inch skirting all around the walls complete in all respects as per site requirements and as directed by the Engineer In-charge. Sample to be submitted before approval.	60	Rft		
21	Providing & fixing of approved quality PVC laminated wooden reducer of approved quality of suitable size and thickness fixed at ends of flooring including the cost of glue / screws / nail etc. complete in all respects as per site requirements and as directed by the Engineer In-charge. Sample to be submitted before approval.	60	Rft		
22	Providing & laying block masonry using 6"x 8"x 12" size solid pre-cast concrete blocks of approved quality set in 1:4 cement-sand mortar including the cost of curing, etc. complete in all respects as per site requirements and as directed by the Engineer In-charge.	850	Sft		
23	Providing, mixing and applying average 3/4" thick cement-sand mortar (1:3) over masonry including the cost of curing, etc. Complete in all respects as per site requirements and as directed by the engineer in-charge.	1900	Sft		
24	Providing and fixing in position, pre-cast RCC roofing slabs having strength of 3000psi casted with 1/4" dia bars @ 6" c/c of IZHAR, Randhawa, Gondal or other approved manufacturer of required size having 2" thickness laid over masonry walls for making deck of stage, including the cost of providing inverted pots of height 18" inside masonry walls, filling of charcoal in the cavity, filling of joints with 1:4 cement-sand mortar, placing, etc complete in all respects as per site conditions and as directed by Engineer In-charge.	800	Sft		
25	Providing & applying required coats (min. 2 coats) of plastic emulsion paint of ICI Dulux, Jotun, Kansapaints or approved equivalent over walls including the cost of scrapping where required, application of wall putty, sand papering, etc.	1000	Sft		

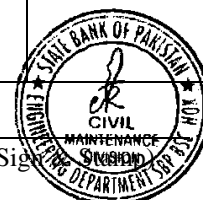

S. No.	Description of Items	Quantity	Unit	Rate (Rs.)	Amount (Rs.)
	complete in all respects as per site requirements and as directed by the Engineer In-charge.				
26	Re-fixing of chairs as per new layout over newly laid carpet tiles with the help of 8mm dia and 3" long stainless steel wedge anchor bolts with SS nut embedded into floor using epoxy of Rawlplug (R-KEX-II) or other approved equivalent make by drilling holes of required size, filling the holes with epoxy and fixing of anchor bolts after laying epoxy including the cost of cleaning the holes from dust, cutting of excess epoxy from the top, cost of drilling, fastening of nuts over bolts after fixing of chair racks, etc. complete in all respects as per site requirements and as directed by the Engineer In-charge.	135	Nos.		
<b>Sub Total Section B:</b>					
<b>Section C: Electrical Works</b>					
27	Supply, installation, testing & commissioning of Ceiling Recessed <b>1x4ft LED Panel lights</b> compliance with at least following Specifications: Power Ratings: 35-40W Color Temperature: 4000K Minimum Lumens: 3600 Efficiency = 100 Lm/W or above Power Factor >= 0.9 Color Rendering Index >= 80 Beam Angle: 120 degree IP Class 40 or above Life span: 50,000 hours or above Thermally conductive plastic-coated Aluminum housing Compliance with IEC Code 60598 or 62471: At least two years warranty, Rate includes the cost of connectors, pins, wires, drivers, Metal frame for supporting the lighting fixtures on the surface and all allied accessories for proper hanging i.e. complete SS hanging kit and connectors etc. with necessary installation material complete in all respects as directed by engineer-in-charge	40	Job		

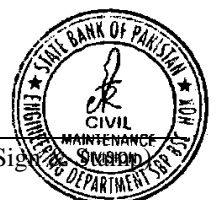

S. No.	Description of Items	Quantity	Unit	Rate (Rs.)	Amount (Rs.)
28	<p>Supply, installation, testing &amp; commissioning of Ceiling Recessed <b>LED Down lights</b> compliance with at least following Specifications:</p> <p>Power Ratings: 10-12W            Color Temperature: 03CCT 3000K/4000K/6500K            Control: Dimmable            Minimum Lumens: 940            Efficiency = 90 Lm/W or above            Power Factor <math>\geq 0.9</math>            Color Rendering Index <math>\geq 80</math>            Beam Angle: 90 degree            Cutout size: 90mm            IP Class 40 or above            Life span: 40,000 hours or above            Thermally conductive plastic-coated Aluminum housing Compliance with IEC Code 60598 or 62471:            At least two years warranty, including the cost of joining connectors, pins, wires, leads whatever essential, complete in all respect as per manufacturer standard) with necessary fitting, fixing material, drilling, chipping, wall cutting and repairing as per original, connections complete in all respects</p>	30	Job		
29	<p>Supply, installation, testing &amp; commissioning of Ceiling Recessed <b>LED Spot lights</b> compliance with at least following Specifications:</p> <p>Power Ratings: 08-10W            Color Temperature: 03CCT 3000K/4000K/6500K            Minimum Lumens: 760            Efficiency = 90 Lm/W or above            Power Factor <math>\geq 0.9</math>            Color Rendering Index <math>\geq 80</math>            Beam Angle: 45 degree            Cutout size: 90mm            IP Class 20 or above            Life span: 50,000 hours or above            Thermally conductive plastic-coated Aluminum housing Compliance with IEC Code 60598 or 62471:            At least two years warranty, including the cost of joining connectors, pins, wires, leads whatever essential, complete in all respect as per manufacturer standard) with necessary fitting, fixing material, drilling, chipping, wall cutting and repairing as per original, connections complete in all respects</p>	45	Job		



S. No.	Description of Items	Quantity	Unit	Rate (Rs.)	Amount (Rs.)
30	<p>Supply, installation, testing &amp; commissioning of Ceiling Recessed <b>4ft LED Linear lights</b> compliance with at least following Specifications:            Power Ratings: 30-40W            Color Temperature: 03CCT 3000K/4000K/6500K            Minimum Lumens: 3000            Efficiency = 100 Lm/W or above            Power Factor <math>\geq 0.9</math>            Color Rendering Index <math>\geq 80</math>            Beam Angle: 110 degree            IP Class 20 or above            Life span: 50,000 hours or above</p> <p>Thermally conductive plastic-coated Aluminum housing Compliance with IEC Code 60598 or 62471:            At least two years warranty,            Rate includes the cost of connectors, pins, wires, drivers, Meta frame for supporting the lighting fixtures on the surface and all allied accessories for proper hanging i.e. complete SS hanging kit and connectors etc. with necessary installation material complete in all respects as directed by engineer-in-charge</p>	50	Job		
31	<p>Supply, installation, testing &amp; commissioning of <b>LED Step lights</b> with following specifications:            Power Rating 5-10 Watts            Shape: Rectangular            Color Temperature 3000K            Efficiency <math>\geq 80</math> Lm/W            Power Factor <math>\geq 0.8</math>            Color Rendering Index <math>\geq 80</math>,            IP Class 40 or above,            Warranty: at least 2 year or above including the cost of joining connectors, pins, wires, leads whatever essential, complete in all respect as per manufacturer standard) with necessary fitting, fixing material, drilling, chipping, wall cutting and repairing as per original, connections complete in all respects</p>	30	Nos.		
32	<p>Supply, installation, testing, and commissioning of <b>lighting circuit wiring</b> for LED lights mentioned in above item nos. 01 &amp; 02 by using: 2 x 2.5mm sqr. &amp; 1.5mmsqr. as ECC copper/PVC wire (Electrical wiring must be compliant with IEC 60364 or BS 7671 and type tested certification from KEMA/RAWAT/PQSIR) and            PVC pipe of 25 mm dia of class C (Electrical PVC pipe must be in compliant with BS 6099-1 or PS 1905-87 standards)</p> <p>The cost includes supply, laying, and installation of wires in PVC conduit pipe with all necessary installation material and redressing as per original</p>	500	Mtr		

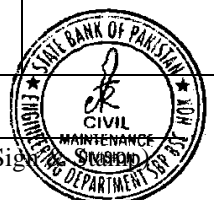



S. No.	Description of Items	Quantity	Unit	Rate (Rs.)	Amount (Rs.)
	condition, complete in all respects as per standard industry practice to the satisfaction of the Engineer In-charge				
33	<p>Supply, installation, testing, and commissioning of <b>light point and point to point wiring</b> using: 3 x 1.5mm sqr. PVC wire (Electrical wiring must be compliant with IEC 60364 or BS 7671 and type tested certification from KEMA/RAWAT/PQSIR) and PVC pipe of 25 mm dia of class C (Electrical PVC pipe must be in compliant with BS 6099-1 or PS 1905-87 standards)</p> <p>The cost includes supply, laying, and installation of wires in PVC conduit pipe with all necessary installation material and redressing as per original condition, complete in all respects as per standard industry practice to the satisfaction of the Engineer In-charge</p>	2200	Mtr		
34	Supply and installation of <b>Power switch socket sheet/Multisocket</b> of 15A power capacity make Clipsal or equivalent and powder coated MS back box with fixing material by observing beauty and proper level on wall from floor level. Complete in all respects as directed by engineer-in-charge.	20	Nos.		
35	Supply and installation of <b>05 Gang switch sheets/face plates</b> of with powder coated concealed back box 3"x3" with fixing material by observing beauty and proper level on wall from floor level. Complete in all respects as directed by engineer-in-charge.	12	Nos.		
36	<p>Supply, installation &amp; fixing of <b>MS cable tray of size 3"x 6"x 3"</b> 18SWG, with cover, capsule perforated, one coat of red oxide and two coated of enamel paint, provided with MS brackets, 8mm anchor bolts for hanging of cable tray on the wall, ceiling and all required material required for installation.</p> <p>The cost includes cutting, bending, providing &amp; fixing of MS brackets with 8mm anchor bolts for hanging of cable tray on the wall and ceiling, fixing of rubber gasket on sharp edges complete in all respect &amp; as directed by engineer in-charge</p>	100	Mtr		
37	<p>Supply, installation, testing, and commissioning of <b>shielded 02-core flexible wire 0.75mmsq for speakers of sound system</b> using PVC pipe of 25 mm dia of class C (Electrical PVC pipe must be in compliant with BS 6099-1 or PS 1905-87 standards)</p> <p>The cost includes supply, laying, and installation of wires in PVC conduit pipe with all necessary installation material and redressing as per original condition, complete in all respects as per standard</p>	200	Mtr		



S. No.	Description of Items	Quantity	Unit	Rate (Rs.)	Amount (Rs.)
	industry practice to the satisfaction of the Engineer In-charge				
<b>Sub Total Section C:</b>					
<b>Section D: Mechanical/Air Conditioning Works</b>					
38	Dismantling, removal & shifting of existing ducting to designated place earmarked for temporary storage. All work shall be carried out in a manner that the ducting, accessories, insulation etc. shall remain undamaged. The Job involves work-at-height and would require permanent scaffold structure. Complete in all respect as directed by the Engineer In-charge	8000	Sft		
39	Re-fixing, testing & commissioning of ducting as per existing layout with properly sealed duct joints, gaskets & other consumables. The Job involves work-at-height and would require permanent scaffold structure. Restoration of site as per original. Complete in all respect as directed by the Engineer In-charge	8000	Sft		
40	Supply, Installation, testing & Commissioning of medium/low pressure G.I. sheet metal ducting complete in all respect as per drawings, specifications along with hangers and supports for HVAC ducting. The specs shall follow SMACNA standard(s). Complete in all respect as directed by Engineer In-charge.	3000	Sft		
41	Supply and installation of 25 mm Thick Fiber Glass Insulation of density 16 kg/m <sup>3</sup> with Aluminum Foil for Internal G.I. sheet metal ducts of different sections for supply/return air duct with Aluminum tape. Complete in all respect as per schedule, specifications and drawings and as directed by Engineer In-charge.	4000	Sft		
42	Supply & Installation of 8 oz Canvas Cloth wrapping. Complete in all respect as per schedule, specifications and drawings and as directed by Engineer In-charge.	8000	Sft		
43	Supply, installation, testing and commissioning of new 3 TR Wall Mounted Decorative type Fan Coil Unit with net cooling capacity not less than 30,000 BTU/h For Dining Area. Complete in all respect as per schedule, specifications and drawings and as directed by Engineer In-charge.	5	No.		
44	Supply, installation, testing and commissioning of new 3 TR Ducted Type Metal Body Fan Coil Unit with net cooling capacity not less than 30,000 BTU/h. Complete in all respect as per schedule, specifications and drawings and as directed by Engineer In-charge.	1	No.		
45	Dismantling, removal & shifting of existing 10TR ducted type fan coil unit to designated area. The Job shall include proper closure of CHW piping with proper fiberglass/PU with kraft paper insulation & cladding. Complete in all respect as directed by the Engineer In-charge	1	Job		

For Bidder (Sign &amp; Stamp)

For SBP BSC (Sign &amp; Stamp)

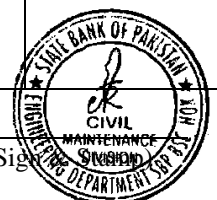

S. No.	Description of Items	Quantity	Unit	Rate (Rs.)	Amount (Rs.)
46	Supply & Installation of Sound Liner (Fiber) for Ducting for Sound Dampening of HVAC Ducts in Sections of High Velocity. Complete in all respect as per schedule, specifications and drawings and as directed by Engineer In-charge	2000	Sft		
47	Dismantling, Repairing, Paint Powder, Coating & Re-installation of existing air devices (SAD Diffusers, RAD Grills etc.). Complete in all respect as per schedule, specifications and drawings and as directed by Engineer In-charge	150	Sft		
48	Repairing & Servicing of Existing Volume Control Air Dampers. Complete in all respect as per schedule, specifications and drawings and as directed by Engineer In-charge	6	Job		
49	Dismantling, Repairing, Paint & Re-installation of 04 TR Floor Standing Split Type Air-conditioners with new closed-cell insulation for copper piping. Complete in all respect as per schedule, specifications and drawings and as directed by Engineer In-charge	2	Job		
50	Supply & Application of Anti-Fungus Paint for HVAC Ducts (Zahabiya or approved equivalent). Complete in all respect as directed by Engineer In-charge.	8000	Sft		
51	Services for making return air passage for Air Handling Units. The Job shall include: 1. Civil Works of creation of openings & finishing of Site. 2. Installation of Two New powder coated Aluminum Return Air Grill. 3. Installation of Two Volume Control Dampers to be installed with Return Grills 4. Includes Material & Services costs.  Complete in all respect as per schedule, specifications and drawings and as directed by Engineer In-charge	1	Job		
52	Services for overhauling of Air Handling Unit. Services includes:  1. Repairing of Body with metal sheet panel injected with Polyurethane injection. 2. Repairing of Side Plates of CHW coils 3. Scraping, application of Red Oxide Primer and application of Fiber Coat. 4. Servicing of complete air handling unit as per manufacturer guidelines.	2	Job		
<b>Sub Total Section D:</b>					
<b>Section E: Fire Fighting/Sight screen works</b>					

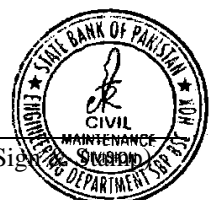

S. No.	Description of Items	Quantity	Unit	Rate (Rs.)	Amount (Rs.)
53	Supply of addressable optical-type smoke detector with standard base and following minimum specifications: Smoke Detector - Addressable Operative voltage - 8-42 VDC Current approx- 50 $\mu$ A Temperature -20 C to 72 C Protection - IP 40 Dimension approx. - $\phi$ 117 mm H 49 mm (62 mm inclusive base) Approval - EN 54-7/-17.2005 or approved equivalent	16	Nos		
54	Supply and installation of fire resistant cable (300/500V), LPCB approved, Plain annealed copper. Solid (1.0 - 2.5 mm <sup>2</sup> ) or stranded circular conductors (4.0 mm <sup>2</sup> ) to meet the requirements of BS EN 60228 class 1 or class 2 , shielded fire resistant 120 minutes (PH120) cable in conduit to be run in ceiling, wall, surface as per the site requirement including relevant civil works such as cutting, chipping, plaster, paint and finishing back as per original as directed by Engineer In-charge	350	Mtr		
55	Installation, Testing & commissioning of entire system along with the training of employer's personnel.	1	Job		
56	Supply of minimum 100" LED screens as per below Technical Requirements & Standards/Specifications; Phase Single Input Volts 220 – 240 Volts Input Volts Frequency 50/60 Hz Product Type Smart Android TV Display Size 100 Inches, as applicable Display Resolution Min 3840 x 2160 / 4 K Display Type Min (UHD) Contrast High Dynamic Range 10 (HDR 10) or extended feature CPU Min 64bit & 1.2 GHz or advanced RAM / ROM Min 2GB or extended feature Audio Integrated Speakers Boxes Audio Output Min 18watt with Bluetooth audio (optional) or advanced Connectivity HDMI Port, USB Port, TV Cable Port, Internet Link 2.4GHz or above with Wifi Connectivity any additional feature. Warranty Minimum Two (2) years manufacturer warranty Standard Package Sealed standard packing contain, polythene wrapped / boxed remote control device, wall mounting iron brackets, table stands along with screws, bolts etc. as provided by manufacturer	2	Nos.		



S. No.	Description of Items	Quantity	Unit	Rate (Rs.)	Amount (Rs.)
57	Installation, Testing & commissioning of above LED's including fixing on brackets clamped on suspended frames fixed above ceiling, wiring/cabling required for electrical and connection with existing multimedia system with necessary installation material complete in all respects as directed by engineer-in-charge	1	Job		
<b>Sub Total Section E:</b>					
<b>Section A : Dismantling, Repair &amp; Structural Works</b>					
<b>Section B : Architectural Works</b>					
<b>Section C: Electrical Works</b>					
<b>Section D: Mechanical/Air Conditioning Works</b>					
<b>Section E: Fire Fighting/Sight screen works</b>					
<b>Grand Total = A+B+C+D+E</b>					

In words (Rs.)

\_\_\_\_\_

\_\_\_\_\_ Only

For Bidder (Sign & Stamp)

For SBP BSC (Sign & Stamp)

